

CONTACT US!

ALL PRICES WILL BE DISCOUNTED EVEN MORE!

Call DICK JONES SALES 800-441-9955 or

E-mail DickJones@DickJonesSales.com

WAREHOUSE SOLUTIONS



TENNSCO® Bulk Racks
See page 5



HUSKY™ Invincible™ Pallet Racks
See page 6



JARKE™ Steeltree® Heavy-Industrial Grade Cantilever Racks
See page 8



HERCULES® Premium Scale Pallet Truck
See page 15

BULK STORAGE AREA
Pgs 4-15 →



QUANTUM STORAGE SYSTEMS Pick Racks
See page 19



RELIUS SOLUTIONS™ Ultra Deep-Door Security Bin Cabinets
See page 20



EDSAL Premium Shelving
See page 22



RELIUS SOLUTIONS™ Wire Gravity Flow Shelving
See page 24

SMALL STORAGE AREA
Pgs 16-25 →



EAGLE Flammable Liquids Safety Cabinets
See page 28



RELIUS SOLUTIONS™ Cylinder Storage Cabinets
See page 29



RELIUS ELITE™ Premium Security Box Trucks
See page 30

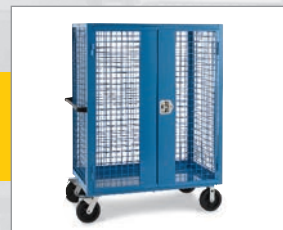

RELIUS ELITE™ Wire Security Trucks
See page 31

SECURE STORAGE AREA
Pgs 26-31 →



HALLOWELL Modular Storage Lockers
See page 32



HUSKY™ Perimeter Guards
See page 33



WILDECK Wilgard® Two-Rib Steel Protective Railing Systems
See page 34

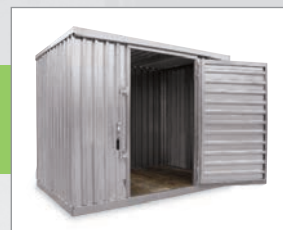

VESTIL Quick-Assembly High-Security Storage Sheds
See page 34

EQUIPMENT STORAGE AREA
Pgs 32-35 →

WAREHOUSE

Meet your warehouse space optimization goals with a wide variety of affordable storage solutions. Find bulk containers, small storage options, secure storage products and equipment storage for all areas of your warehouse. Revamp your storage solutions for less—from racking to bins, we've got it covered!

EXCLUSIVE brands for you!



Additional sizes can be found on page 12. Call for color options.



Collapsible Wire Containers

- Steel wire
- 4-way fork access
- Stackable

High-strength, lightweight containers add less weight to shipping costs. Welded, square mesh wire. Include half-drop side gates and caster pads. 4" underclearance. **IN STOCK.**

Collapsible Wire Containers with Zinc-Plated Finish

Optional casters sold separately. Specify: (01) container only, (02) container with lid. **IN STOCK.**

Overall WxLxH	Cap. Lbs.	Cap. Cu. Ft.	Inside Height	Collapsed Height	Drop Gate Side	Mesh Size	Mesh Gauge	CONTAINER		CONTAINER WITH LID	
								Stock Number	\$	Stock Number	\$
48x40x35"	4000	30.8	29.78"	8 1/4"	48"	2"	3	3527601-V	239.00	3527602-V	278.00
3527800-V	Optional 4x2" phenolic casters. \$.....										69.60



Specially designed cast steel pump.



Premium 6600-Lb. Capacity Pallet Truck

• 5-year warranty
Built to last with extra-thick steel and reinforced fork bracing. Reinforced spring-loaded ergonomic handle includes rubber covered top and 3-position raise, lower, and neutral fingertip controls. Extra-large bearing under apron head for smoother maneuverability. Specially designed cast steel pump. Orange powder coat finish. **IN STOCK.**

Fork Width, Overall	Fork Length, Overall	Stock Number	\$
21"	48"	7873304-V	459.00
27"	48"	7873308-V	479.00

SOLUTIONS

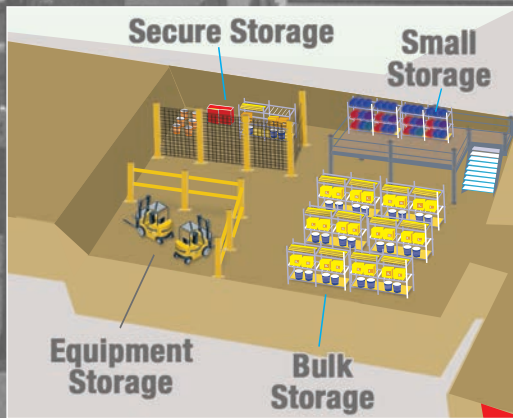

BULK STORAGE AREA

Pgs 4-15

SMALL STORAGE AREA

Pgs 16-25

SECURE STORAGE AREA

Pgs 26-31

EQUIPMENT STORAGE AREA Pgs 32-35

Perfo panel accessories not included. Please call for hooks, clamps, etc.

SHIPS SAME DAY!

Relius
solutions

Deep-Door Security Cabinets

- 800-lb. capacity per shelf
- 16-gauge steel
- All-welded
- Padlock hasp with single-point lock

"Universal," all-in-one, premium-series cabinets store all your tools and supplies. High-security padlock hasp prevents cutting devices from reaching lock. 30 1/2"Wx16 7/8"Dx4"H, 75-lb. capacity drawers have 100% full-extension ball-bearing glides. Drawers may be divided into (16) 4x7 1/2" compartments with removable dividers provided. Removable Akro-Bins® hang from louvered panels. Made in USA. *IN STOCK.*

Eight-Drawer Cabinet with 96 Bins

Includes (96) 5 7/8"Lx4 1/8"Wx3"H bins. 17 3/4"Wx34 1/2"H perfo panel accepts BOTT hooks and accessories.

Overall WxDxH	Stock No.	\$
36x24x72"	8414200-V	3381.00



Heavy-Duty Self-Dumping Containers

- 7-gauge steel
- Up to 8000-lb. capacity

Automatic latch unlocks easily as forklift tilts container releasing the door and emptying the load. As container is lowered to the ground, latch resets and securely locks the door. Casters are available, call for information. Made in USA.

Cap. Lbs.	Cap. Cu. Yd.	Overall LxWxH	Fork Pocket WxH	Stock Number	\$
6000	3	69x58x56"	42x3"	2010300-S	1861.00

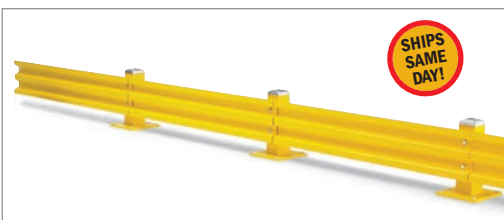

SHIPS SAME DAY!

Relius
solutions

Protective Railing System

- 14-gauge steel
- Unassembled components
- Mounting hardware included

Overlapping rails bolt together on the front of the support posts to form an uninterrupted barrier. Rails are customizable in the field—can be cut to any length. Rails and posts sold separately. Made in USA. *IN STOCK.*

Rails

Overall Lgth.	Stock No.	\$
10'	7811000-U	183.00
6'	7811100-U	150.00

Post

Overall Ht.	Stock No.	\$
18"	7811900-U	276.00

BULK STORAGE AREA



SECTIONAL INDEX

Bulk Shelving.....4-5
 Pallet Racks.....6-7
 Cantilever Racks8-9
 Partitions.....10-11
 Bulk Containers.....12-13
 Pallet Trucks14-15

Store, move and organize bulk products efficiently within your warehouse with versatile options. Reduce storage costs by decreasing your storage footprint with space-saving solutions. Call us for information on these possibilities and more.



tennisco Reinforced Shelving

- *Ultra-Capacity: 14-gauge steel posts; 16-gauge steel shelves*
- *Shelf capacity: up to 4000 lbs., capacities based on evenly distributed loads*
- *Unassembled*

Unique cross beam supports provide maximum shelf capacity. Braceless design permits access from all sides. Comes complete with (5) shelves that adjust in 1 1/2" increments. Powder-coat finish. Color: gray. Made in USA. **SELECTED MODELS IN STOCK AND FACTORY QUICK SHIP.**

Overall WxDxH	Shelf Cap. Lbs.	Shelf Qty.	Stock No.	\$
36x18x72"	4000	5	5171900-S	338.00
36x24x72"	4000	5	5173100-S	390.00
48x18x72"	4000	5	5172000-S	405.00
48x24x72"	4000	5	5172100-S	454.00
60x24x72"	3250	5	5172200-S	536.00
72x24x72"	2750	5	5172300-S	613.00
72x36x72"	2750	5	5695600-S	869.00
96x24x72"	2600	5	5695700-S	902.00
96x36x72"	2600	5	5695800-S	1141.00
36x18x84"	4000	5	5695900-S	345.00
36x24x84"	4000	5	5696000-S	400.00
48x18x84"	4000	5	5696100-S	412.00
48x24x84"	4000	5	5172400-S	460.00
60x24x84"	3250	5	5172500-S	544.00
72x24x84"	2750	5	5172600-S	652.00
72x36x84"	2750	5	5173200-S	879.00
96x24x84"	2600	5	5172700-S	909.00
96x36x84"	2600	5	5696200-S	1153.00
36x18x96"	4000	5	5172800-S	353.00
36x24x96"	4000	5	5696300-S	408.00
48x18x96"	4000	5	5173700-S	420.00
48x24x96"	4000	5	5172900-S	471.00
60x24x96"	3250	5	5173000-S	550.00
72x24x96"	2750	5	5696400-S	661.00
72x36x96"	2750	5	5696500-S	886.00
96x24x96"	2600	5	5696600-S	919.00
96x36x96"	2600	5	5173800-S	1160.00

Beam-hook connection



Bulk Racks

- **Standard-Industrial:** 14-gauge steel upright frame; 14-gauge steel beam
- **Beam-hook connection**
- **Shelf capacity:** up to 4150 lbs.; capacities based on evenly distributed loads
- **Shelf level quantity:** 3
- **Welded upright frame**

Pre-welded upright frames and rolled formed steel box beams on shelf frames add strength. Z-shape beam design increases capacity. Each shelf level includes a shelf frame with built-in decking support angle. Shelf levels adjust in 2" increments. Three decking choices: economical particleboard; wire for better air flow and visibility; or smooth, fire-retardant steel. Starters can be used individually or combined with add-ons to complete a row of shelving. 17,000-lb. overall capacity. Color: medium gray. Made in USA. **SELECTED MODELS FACTORY QUICK SHIP.**



48x24x72" Starter unit with particleboard decking shown.



Starters include: (2) upright frames and (3) shelf levels.



Add-ons include: (1) upright frame and (3) shelf levels.

Shelf Supports per Shelf Level

48"W	2
72"W	3
96"W	4

All required shelf supports are included.

Overall WxDxH	Shelf Cap. Lbs.	PARTICLEBOARD DECKING					
		STARTER UNITS		ADD-ON UNITS		EXTRA LEVELS	
		Stock No.	\$	Stock No.	\$	Stock No.	\$
48x24x72"	4150	5801001-T	269.00	5801101-T	217.00	5804100-T	53.80
48x36x72"	4150	5801201-T	308.00	5801301-T	250.00	5804200-T	62.50
72x24x72"	2750	5802501-T	344.00	5802601-T	290.00	5804400-T	78.40
72x36x72"	2750	5802701-T	391.00	5802801-T	336.00	5804500-T	92.10
96x24x72"	2150	5803501-T	412.00	5803601-T	358.00	5804700-T	102.00
96x36x72"	2150	5803701-T	478.00	5803801-T	422.00	5804800-T	120.00
48x24x96"	3000	5801002-T	305.00	5801102-T	235.00	5804100-T	53.80
48x36x96"	3000	5801202-T	351.00	5801302-T	271.00	5804200-T	62.50
72x24x96"	2750	5802502-T	380.00	5802602-T	311.00	5804400-T	78.40
72x36x96"	2750	5802702-T	436.00	5802802-T	357.00	5804500-T	92.10
96x24x96"	2150	5803502-T	447.00	5803602-T	376.00	5804700-T	102.00
96x36x96"	2150	5803702-T	522.00	5803802-T	444.00	5804800-T	120.00
96x24x120"	2150	5803503-T	482.00	5803603-T	394.00	5804700-T	102.00
96x36x120"	2150	5803703-T	549.00	5803803-T	455.00	5804800-T	120.00
96x48x120"	2150	5803903-T	616.00	5804003-T	516.00	5806900-T	147.00

Overall WxDxH	Shelf Cap. Lbs.	WIRE DECKING						CORRUGATED STEEL DECKING					
		STARTER UNITS		ADD-ON UNITS		EXTRA LEVELS		STARTER UNITS		ADD-ON UNITS		EXTRA LEVELS	
		Stock No.	\$	Stock No.	\$	Stock No.	\$	Stock No.	\$	Stock No.	\$	Stock No.	\$
48x24x72"	3800	5905200-T	321.00	5908300-T	280.00	5910500-T	75.20	5837001-T	345.00	5837101-T	292.00	5838800-T	78.30
48x36x72"	3800	5905300-T	386.00	5909400-T	340.00	5910600-T	94.80	5837201-T	409.00	5837301-T	352.00	5838900-T	96.50
72x24x72"	2750	5905400-T	419.00	5909500-T	382.00	5910700-T	114.00	5837601-T	438.00	5837701-T	383.00	5839100-T	110.00
72x36x72"	2750	5905500-T	584.00	5909600-T	492.00	5910800-T	151.00	5837801-T	526.00	5837901-T	469.00	5839200-T	144.00
96x24x72"	2150	5905600-T	508.00	5909700-T	481.00	5910900-T	147.00	5838201-T	534.00	5838301-T	483.00	5839400-T	151.00
96x36x72"	2150	5905700-T	631.00	5909800-T	599.00	5911300-T	190.00	5838401-T	652.00	5838501-T	595.00	5839500-T	184.00
48x24x96"	3800	5905800-T	356.00	5909900-T	301.00	5910500-T	75.20	5837002-T	379.00	5837102-T	310.00	5838800-T	78.30
48x36x96"	3800	5906100-T	425.00	5910000-T	357.00	5910600-T	94.80	5837202-T	451.00	5837302-T	375.00	5838900-T	96.50
72x24x96"	2750	5906200-T	470.00	5910100-T	401.00	5910700-T	114.00	5837602-T	472.00	5837702-T	403.00	5839100-T	110.00
72x36x96"	2750	5906300-T	578.00	5910200-T	513.00	5910800-T	151.00	5837802-T	570.00	5837902-T	492.00	5839200-T	144.00
96x24x96"	2150	5906400-T	569.00	5910300-T	500.00	5910900-T	147.00	5838202-T	570.00	5838302-T	500.00	5839400-T	151.00
96x36x96"	2150	5906500-T	687.00	5910400-T	618.00	5911300-T	190.00	5838402-T	695.00	5838502-T	617.00	5839500-T	184.00
96x24x120"	2150	5924400-T	607.00	5925700-T	519.00	5910900-T	147.00	5838203-T	606.00	5838303-T	519.00	5839400-T	151.00
96x36x120"	2150	5924500-T	714.00	5925800-T	617.00	5911300-T	190.00	5838403-T	723.00	5838503-T	628.00	5839500-T	184.00
96x48x120"	2150	5924800-T	867.00	5925900-T	754.00	5911400-T	230.00	5838603-T	841.00	5838703-T	740.00	5839600-T	216.00

Ships same day for 1-3 day delivery

Ships 1-5 days

STOCK, STORE & MORE

USING PALLET RACKS WITH WIRE DECKING



Call for Complete Rack and Deck Systems with Heavy Load Upright Frames.



Invincible™ Complete Rack and Deck System

- Welded upright frames
- Upright frame maximum capacities from 19,380 to 28,800 lbs.
- Patented Bowlock® safety clip securely attaches beam to upright

Rugged, high-strength steel construction allows 2" beam adjustability. One-piece tubular beams feature a continuous seam weld. A minimum of 2 pairs of beams are required for each storage bay. Safety certified 55,000 lbs. psi minimum yield high-strength steel used throughout. Upright frames include foot plates. Complete starters include 2 upright frames, 4 solid beams, and 4 wire decks while the add-ons include 1 upright frame, 4 solid beams, and 4 wire decks. Heavy-duty foot plates are available for seismic requirements. Polyurethane paint finish on upright frames and beams. Upright frame style change as of April 2012; beams are interchangeable. Color: orange beams and green upright frames. Made in USA. *IN STOCK.*

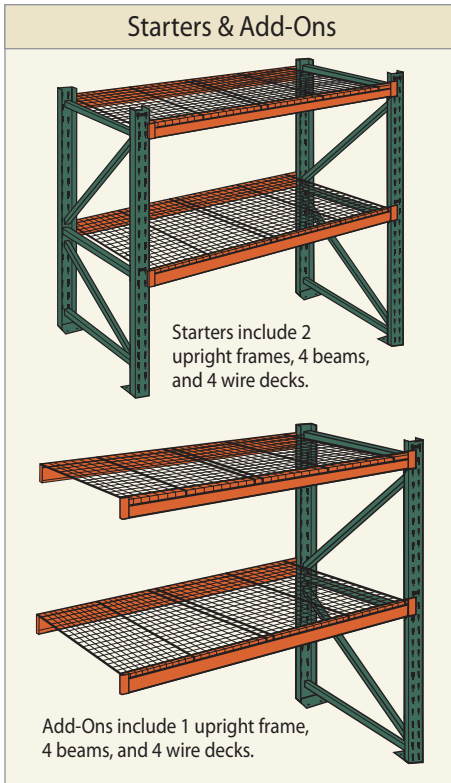

Overall WxDxH	Beam LxH	Beam Cap. Lbs./Pair	STARTER		ADD-ON	
			Stock No.	\$	Stock No.	\$
96x36x96"	96x3"	3052	7848900-T	406.00	7849200-T	328.00
96x36x96"	96x3.5"	4044	7975000-T	419.00	7978200-T	339.00
96x36x96"	96x4"	5047	5734600-T	426.00	5737100-T	347.00
96x36x96"	96x4.3"	6111	7975100-T	429.00	7978300-T	349.00
96x36x96"	96x5"	7286	5734700-T	440.00	5737200-T	361.00
96x42x96"	96x3.5"	4044	7975200-T	435.00	7978400-T	355.00
96x42x96"	96x4"	5047	5734800-T	443.00	5737300-T	362.00
96x42x96"	96x4.3"	6111	7975300-T	445.00	7978500-T	365.00
96x48x96"	96x3.5"	4044	7975400-T	455.00	7978600-T	370.00
96x48x96"	96x4"	5047	5735000-T	464.00	5737500-T	379.00
96x48x96"	96x4.3"	6111	7975500-T	465.00	7978700-T	380.00
96x48x96"	96x5"	7286	5735100-T	478.00	5737600-T	393.00
108x36x96"	108x4.3"	5000	7975600-T	455.00	7978800-T	375.00
108x42x96"	108x4.3"	5000	7975700-T	470.00	7978900-T	389.00
108x48x96"	108x4.3"	5000	7975800-T	490.00	7979000-T	405.00
120x36x96"	120x4.3"	4062	7975900-T	489.00	7979100-T	409.00
120x36x96"	120x5"	5228	5735200-T	500.00	5737700-T	421.00
120x42x96"	120x4.3"	4062	7976000-T	509.00	7979200-T	425.00
120x42x96"	120x5"	5228	5735300-T	523.00	5737900-T	441.00
120x48x96"	120x4.3"	4062	7976100-T	535.00	7979300-T	449.00
120x48x96"	120x5"	5228	5735400-T	546.00	5738000-T	462.00
96x42x120"	96x3.5"	4044	7976400-T	485.00	7979600-T	375.00
96x42x120"	96x4.3"	6111	7976500-T	495.00	7979700-T	389.00
108x36x120"	108x4.3"	5000	7976600-T	499.00	7979800-T	395.00
108x42x120"	108x4.3"	5000	7976700-T	519.00	7979900-T	415.00
120x36x120"	120x4.3"	4062	7976800-T	560.00	7980000-T	459.00
120x42x120"	120x4.3"	4062	7976900-T	589.00	7980100-T	480.00
120x42x120"	120x5"	5228	5736000-T	571.00	5738600-T	465.00
96x36x144"	96x3"	3052	7849100-T	569.00	7849400-T	432.00
96x48x144"	96x3.5"	4044	7977400-T	529.00	7980600-T	409.00
96x48x144"	96x4"	5047	5736600-T	687.00	5739100-T	565.00
96x48x144"	96x4.3"	6111	7977500-T	529.00	7980700-T	435.00
96x48x144"	96x5"	7286	5736700-T	708.00	5739200-T	585.00
108x36x144"	108x4.3"	5000	7977600-T	525.00	7980800-T	409.00
108x42x144"	108x4.3"	5000	7977700-T	540.00	7980900-T	425.00
108x48x144"	108x4.3"	5000	7977800-T	565.00	7981000-T	445.00
120x36x144"	120x4.3"	4062	7977900-T	559.00	7981100-T	445.00
120x36x144"	120x5"	5228	5736800-T	744.00	5739300-T	627.00
120x42x144"	120x4.3"	4062	7978000-T	580.00	7981200-T	465.00
120x48x144"	120x4.3"	4062	7978100-T	605.00	7981300-T	489.00
120x48x144"	120x5"	5228	5737000-T	811.00	5739500-T	688.00

†144" units include (3) upper levels, (6) beams, and (6) wire decks.



Standard or Heavy Load Upright Frames.

Upright frame style change as of April 2012. Made in USA.
 SELECTED MODELS IN STOCK or FACTORY QUICK SHIP.

Frame DxH	STANDARD LOAD		HEAVY LOAD	
	Stock No.	\$	Stock No.	\$
36x96"	7847200-T	80.30	7848200-U	108.00
42x96"	7847300-T	82.10	5781300-T	109.00
48x96"	7847400-T	84.40	7848300-T	113.00
36x120"	7847500-T	106.00	5781500-T	137.00
42x120"	7847600-T	108.00	7848400-T	118.00
48x120"	5779800-T	133.00	7848500-T	120.00
36x144"	7847700-T	119.00	5781800-T	155.00
42x144"	7847800-T	122.00	7848600-T	132.00
48x144"	7847900-U	129.00	7848700-T	135.00
36x168"	5780300-T	168.00	5782100-T	184.00
42x168"	5780400-T	172.00	5782200-T	189.00
48x168"	7848000-T	148.00	5782300-T	193.00
36x192"	7848100-T	153.00	5782400-T	203.00
42x192"	5780700-T	188.00	7848800-U	185.00
48x192"	5780800-T	192.00	5782600-T	211.00
42x216"	5750800-T	213.00	5749800-T	233.00
42x240"	5750900-T	227.00	5749700-T	251.00

Call for pallet rack accessories.



Solid Beams. Two per level required. Made in USA.
 SELECTED MODELS IN STOCK or FACTORY QUICK SHIP.

Beam LxH	Cap. Lbs. per Pair	Step Height	Stock No.	\$
60x3"	6118	1 1/2"	5743200-T	34.00
96x3"	3052	1 1/2"	5709700-T	35.30
96x4"	5047	1 1/2"	5717200-T	38.70
96x4 1/2"	6111	1 1/2"	5732700-T	48.00
96x5"	7286	1 1/2"	5717500-T	42.20
96x5 1/2"	10029	1 1/2"	5717800-T	50.60
108x3"	2494	1 1/2"	5716000-T	46.10
108x4"	4079	1 1/2"	5717300-T	42.30
108x5"	6357	1 1/2"	5717600-T	46.40
108x5 1/2"	8873	1 1/2"	5717900-T	55.70
120x3"	2083	1 1/2"	5720300-T	41.70
120x4"	3378	1 1/2"	5717400-T	55.00
120x5"	5228	1 1/2"	5717700-T	50.30
120x5 1/2"	7505	1 1/2"	5749900-T	60.80
120x6"	8478	1 1/2"	5718000-T	63.50
144x5 1/2"	5569	1 1/2"	5750700-T	71.00
144x6"	7820	1 1/2"	5718700-T	84.00



Galvanized Steel Wire Decking

- Step beam decking • 2x4" mesh
- 6-gauge wire • 14-gauge steel channels

Nothing to fasten—simply drop wire deck in place over rack beams. Low maintenance galvanized steel resists chemicals, rust and corrosion. Fits EDSAL Stor-Master Pallet Racks, HUSKY Invincible Pallet Racks and PENCO Pallet Storage Racks (1 1/2" and 1 7/8" step height only). Made in USA. *IN STOCK.*

Overall WxD	Cap. Lbs.	Channel Qty.	Stock Number	\$
32 1/4" DECK CHANNEL DEPTH				
46x36"	3250	3	5177300-U	28.30
52x36"	3250	3	5177400-U	30.20
58x36"	3900	4	5177500-U	35.50
38 1/4" DECK CHANNEL DEPTH				
46x42"	2610	3	5177600-U	31.80
52x42"	2610	3	5177700-U	33.90
58x42"	3150	4	5177800-U	39.80
44 1/4" DECK CHANNEL DEPTH				
46x48"	2100	3	5178300-U	35.70
52x48"	2100	3	5178500-U	38.20
58x48"	2630	4	5178700-U	44.90



Call for these Pallet Rack Accessories and MORE!



QUANTUM Pallet Rack Bins



CARRON NET Pallet Rack Netting



NASHVILLE WIRE Wire Security Enclosures



UNEX Span-Trak Gravity-Flow Decking



HUSKY Steel Pallet Rack Guards

Ships same day for 1-3 day delivery

Ships 1-5 days

SAFE STORAGE FOR DIMENSIONAL LOADS

CANTILEVER RACKS: COMPLETE OR CUSTOMIZABLE

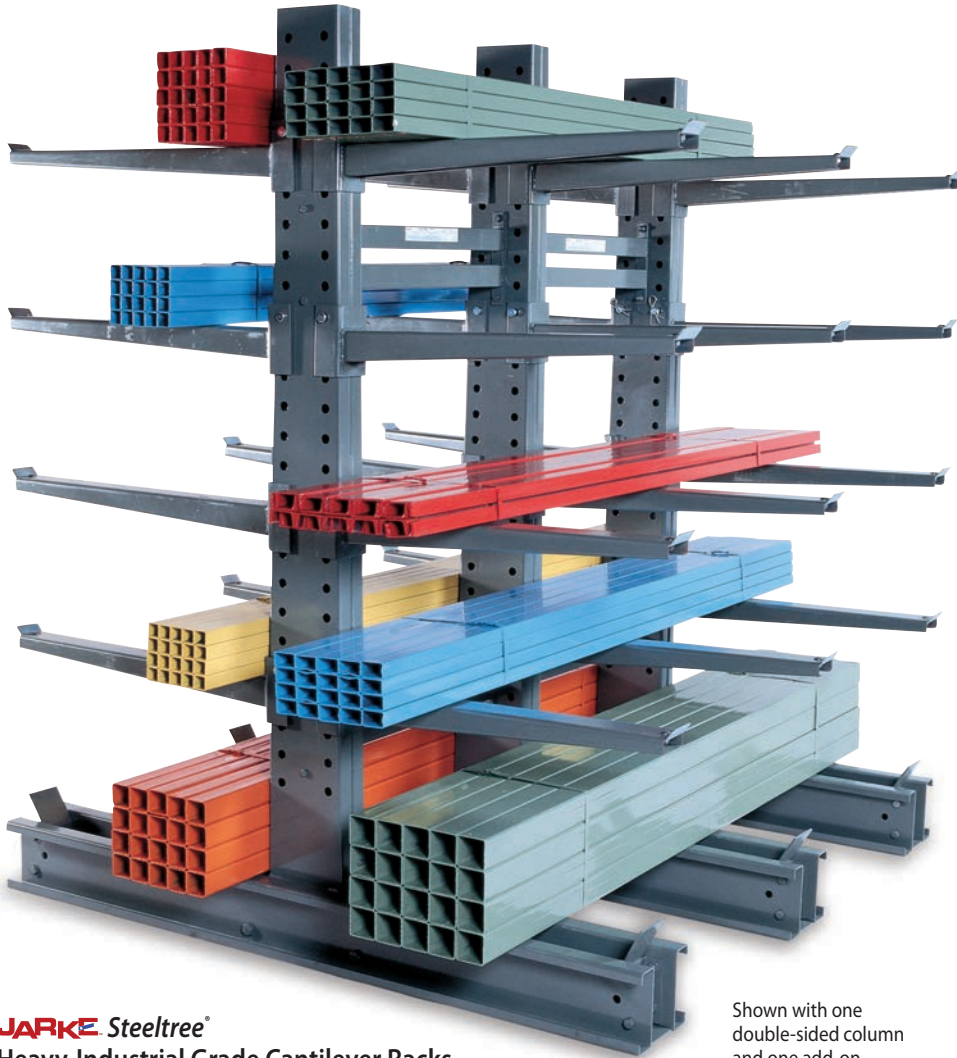

JARKE Steeltree®

Heavy-Industrial Grade Cantilever Racks

- Single-sided column capacity: up to 16,000 lbs.
Double-sided column capacity: up to 32,000 lbs.
- Arm capacity: up to 2000 lbs.
- 8', 10', and 12' heights

Tapered columns have patented internal stiffeners. 10-gauge steel columns. Straight arm with lip adjusts on 3" centers. Made in USA. *SELECTED MODELS IN STOCK.*

Shown with one double-sided column and one add-on.

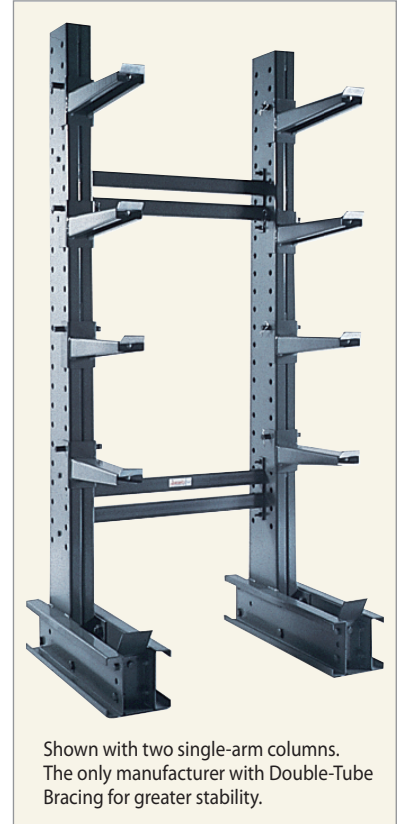

Shown with two single-arm columns. The only manufacturer with Double-Tube Bracing for greater stability.

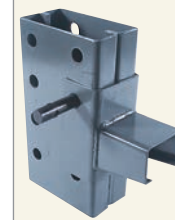

Rugged Arm Construction. Rigid columns are connected to heavy arm saddles for efficient load support.



Secure Pin Lock for Arms and Braces. Is easily inserted or removed to instantly adjust arms. Pin will not work loose when it is secured.

Complete Cantilever Systems

Includes hardware. Ships unassembled.

Overall Height	Base Depth	Cap. Lbs.	Arm Cap. Lbs.	Brace Width	STARTER			ADD-ON		
					Arm Length	Stock No.	\$	Arm Length	Stock No.	\$
SINGLE-SIDED COLUMN										
8'	37"	16,000	2000	(Set of 2) 6'	(8) at 24"	7640900-S	1227.00	(4) at 24"	7641600-S	732.00
10'	46"	15,600	1300	(Set of 3) 6'	(12) at 36"	7641400-S	1851.00	(6) at 36"	7641700-S	1025.00
12'	58"	16,000	1000	(Set of 3) 6'	(8) at 48"	7641500-S	2398.00	(4) at 48"	7641800-S	1295.00
DOUBLE-SIDED COLUMN										
8'	65"	32,000	2000	(Set of 2) 6'	(16) at 24"	7641900-S	1819.00	(8) at 24"	7642600-S	976.00
10'	82"	31,200	1300	(Set of 3) 6'	(24) at 36"	7642400-S	2549.00	(12) at 36"	7642700-S	1479.00
12'	106"	20,000	1000	(Set of 3) 6'	(16) at 48"	7642500-S	3757.00	(8) at 48"	7642800-S	1994.00

Components

Columns. Includes hardware. Ships unassembled.

Overall Height	Arm Length	Max. Cap./Side Lbs.	SINGLE-ARM COLUMN— Sold individually			DOUBLE-ARM COLUMN— Sold individually		
			Stock Number	Base Depth	\$	Stock No.	Base Depth*	\$
8'	12", 18"	18,520, 14,950	7351300-S	31"	390.00	7352500-S	53"	459.00
8'	24"	12,530	7351400-S	37"	412.00	7352600-S	65"	513.00
8'	30", 36"	10,780, 9,460	7351500-S	46"	422.00	7352700-S	82"	529.00
8'	42", 48"	8,430, 7,600	7351600-S	58"	439.00	7352800-S	106"	660.00
10'	30", 36"	14,250, 12,340	7351900-S	46"	500.00	7353100-S	82"	609.00
10'	42", 48"	10,880, 9,730	7352000-S	58"	523.00	7353200-S	106"	741.00
12'	30", 36"	14,160, 12,270	7352300-S	46"	570.00	7353500-S	82"	675.00
12'	42", 48"	10,830, 9,690	7352400-S	58"	585.00	7353600-S	106"	803.00
12'	54", 60"	8,760, 8,000	7359000-S	70"	641.00	7360200-S	130"	753.00

*Maximum capacity for double column is twice value shown.

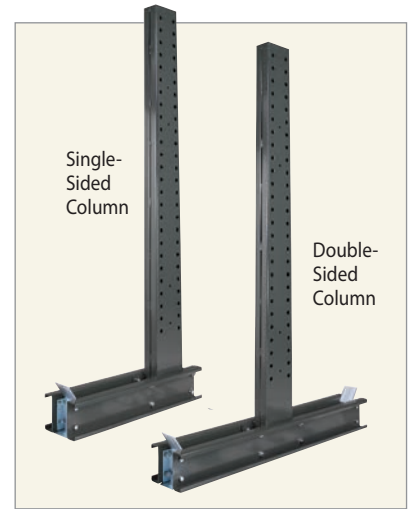

Straight Arms. Pin assembly included.

Overall Length	Arm Cap. Lbs.	NO LIP		WITH LIP	
		Stock No.	\$	Stock No.	\$
EXTRA HEAVY-DUTY ARMS					
36"	3300	7357900-S	121.00	7381200-S	117.00
48"	2500	7368100-S	141.00	7381300-S	145.00
HEAVY-DUTY ARMS					
36"	2175	7356600-S	97.80	7370900-S	102.00
48"	1630	7356800-S	114.00	7380600-S	120.00
STANDARD ARMS					
12"	3000	7353700-S	34.70	7353800-S	38.50
18"	2500	7353900-S	38.70	7354000-S	42.80
24"	2000	7354100-S	42.20	7354200-S	45.70
30"	1600	7354300-S	52.60	7354400-S	55.90
36"	1300	7354500-S	55.10	7354600-S	58.90
42"	1145	7354700-S	58.20	7354800-S	62.30
48"	1000	7354900-S	61.60	7355000-S	65.50
54"	890	7360600-S	65.00	7360700-S	57.80
60"	800	7360800-S	73.30	7360900-S	73.30

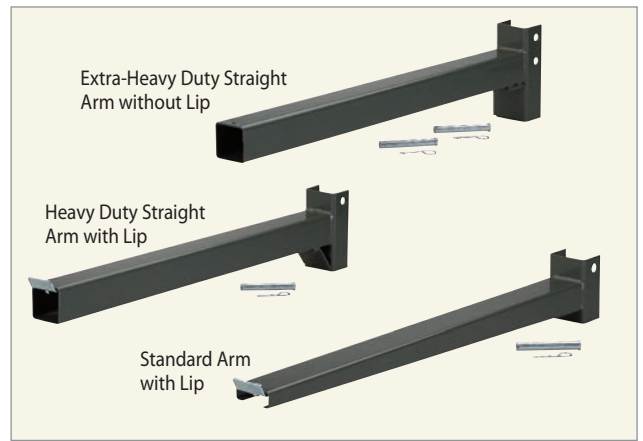

Inclined Arms. Do not have lip. Pin assembly included.

Overall Lgth.	Arm Cap. Lbs.	Stock No.	\$
12"	3000	7355100-S	37.00
18"	2500	7355200-S	40.20
24"	2000	7355300-S	53.40



Brace Sets for Columns.

3–6 ft. wide column centers. Includes hardware. Specify width: (01) 3', (02) 4', (03) 5', (04) 6'.

Column Height	Brace Qty.	Stock Number	(01) 3'	(02) 4'	(03) 5'	(04) 6'
			\$ Set	\$ Set	\$ Set	\$ Set
8'	Set of 2	73554-S	109.00	126.00	140.00	157.00
10' & 12'	Set of 3	73556-S	167.00	188.00	202.00	229.00

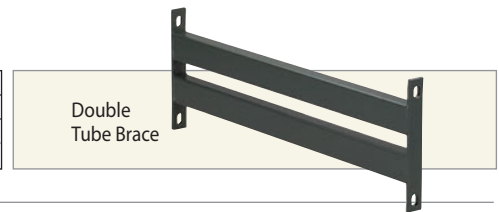

Call for these Storage Racks and MORE!



RELIUS SOLUTIONS
Cantilever Racks



RELIUS SOLUTIONS
Portable Stacking Racks



MECO
Drum Storage Racks



STRUCTURAL PLASTICS
Modular Dunnage Racks

Ships same day for
1-3 day delivery

Ships 1-5 days

SECURE YOUR WORK AREA

PARTITIONS & ENCLOSURES FOR WORK SPACE & STORAGE



Each wire partition shipment receives special care to ensure your order arrives intact. All orders are packaged in wooden crates, as shown for easy handling and no freight damage.

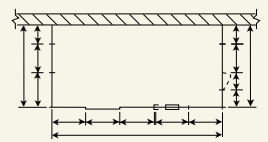

HOW TO ORDER

Make a rough floor plan of area to be enclosed. Note overall measurements. Call for assistance.

Installation Components

INCLUDED WITH ALL PANELS



C-Channel vertical frames for positive alignment between panels, prevents telescoping.



Horizontal stiffener channels securely interwoven thru continuous wire web.



Floor sockets & assembly bolts to connect panels. Stud anchors included for concrete floors.



Top capping channel to span more than one panel—ties top of partitions together (pre-drilled).



Partition System

- Woven wire mesh
- Enamel finish
- Bolted assembly

Easy to set-up, remove and reuse. Can be installed by one person with hand tools. Partitions are interchangeable. Include nuts and bolts. Color: gray. Made in USA. **FACTORY QUICK SHIP.**

Stock-Size Wire Panels. 4 heights

Overall Width	7' HIGH PANELS		8' HIGH PANELS		9' HIGH PANELS		10' HIGH PANELS	
	Stock Number	\$	Stock Number	\$	Stock Number	\$	Stock Number	\$
1'	4713028-S	95.30	4713728-S	104.00	4714228-S	117.00	4714728-S	150.00
2'	4713128-S	118.00	4713828-S	132.00	4714328-S	143.00	4714828-S	167.00
3'	4713228-S	142.00	4713928-S	153.00	4714428-S	169.00	4714928-S	188.00
4'	4713328-S	167.00	4714028-S	176.00	4714528-S	196.00	4715028-S	212.00
5'	4713428-S	177.00	4714128-S	188.00	4714628-S	223.00	4715128-S	229.00



Channel Post.

Use 1 post every 2 panels.

For Panel Height	Stock Number	\$
7'	4723428-S	68.50
8'	4723528-S	77.40
9'	4723328-S	87.30
10'	4723628-S	98.10



Fill-A-Gap Panels

18-ga. sheet steel panels adjust down to 1 1/2" inches, up to 1 ft.

For Panel Height	Stock Number	\$
7'	4716128-S	130.00
8'	4716228-S	141.00
9'	4716728-S	152.00
10'	4716328-S	167.00



Wall Clips. with fasteners.

4721200-W	\$ Pkg./3.....	10.80
4721500-W	1/4" Masonry Anchors.	
	\$.....	2.54
4721600-W	3/8" Masonry Anchors.	
	\$.....	2.57



90° Angle Post

required for each corner

For Panel Height	Stock Number	\$
7'	4723028-T	36.50
8'	4723128-T	38.20
9'	4722728-T	40.30
10'	4723228-T	43.00



Adjustable Corner Post

For Panel Height	Stock Number	\$
7'	4723728-S	64.10
8'	4723828-S	69.40
9'	4722328-S	77.40
10'	4723928-S	81.50



3-Way Clips

needed where 3 panels meet. Floor socket, fittings.

4721300-S	\$ Pkg./3.....	18.10
-----------	----------------	-------



Doors for Partition System

- Enamel finish
- Woven wire mesh
- Bolted assembly

A wide assortment of widths, heights, and door arrangements are available to meet your needs. Please send sketch of top view when ordering. Color: gray. Made in USA. **FACTORY QUICK SHIP.**

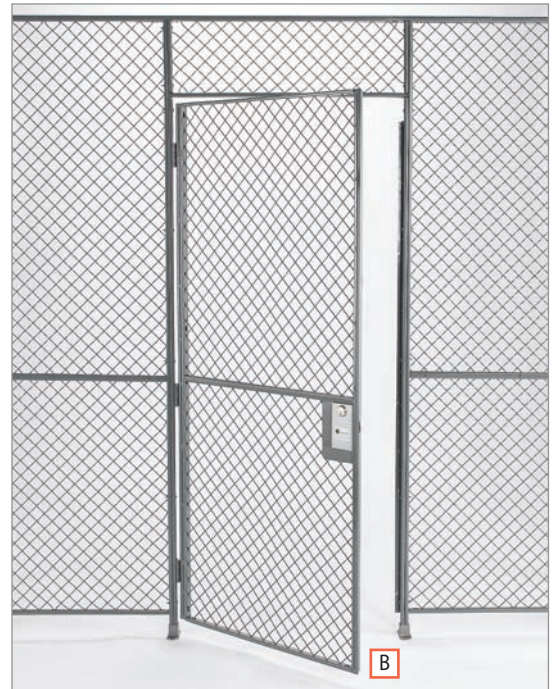

A. Sliding Doors

Designed for mounting outside wire partition. Equipped with ball-bearing hangers. Enclosed track comes with guide and keeper. Doors provide standard 7' height opening. Doors slide left, keyed right outside.

Overall WxH	Cyl. Locks, Keys		w/Padlock Lugs		Cyl. Locks, Keys		w/Padlock Lugs		
	Stock No.	\$	Stock No.	\$	Stock No.	\$	Stock No.	\$	
FULL PARTITION HEIGHT (no transoms)				WITH TRANSOM					
3x7'	4718628-S	625.00	4731828-S	589.00	—	—	—	—	
4x7'	4718728-S	641.00	4731928-S	602.00	—	—	—	—	
5x7'	4718828-S	682.00	4732028-S	644.00	—	—	—	—	
6x7'	4718928-S	764.00	4732128-S	732.00	—	—	—	—	
3x8'	4719428-S	675.00	4732228-S	636.00	4717428-S	485.00	4729528-S	447.00	
4x8'	4719528-S	729.00	4732328-S	683.00	4717528-S	517.00	4729628-S	482.00	
5x8'	4716928-S	832.00	4732428-S	795.00	4717628-S	553.00	4729728-S	515.00	
6x8'	4719628-S	928.00	4732528-S	891.00	4717728-S	675.00	4729828-S	639.00	
4x9'	4724728-S	774.00	4732728-S	740.00	4717928-S	541.00	4730028-S	504.00	
5x9'	4724828-S	903.00	4732828-S	867.00	4718028-S	589.00	4730128-S	551.00	
6x9'	4724928-S	1010.00	4732928-S	883.00	4718128-S	685.00	4730228-S	660.00	
4x10'	4731228-S	808.00	4733128-S	769.00	4718328-S	552.00	4730428-S	515.00	
5x10'	4731328-S	960.00	4733228-S	924.00	4718428-S	604.00	4730528-S	567.00	
6x10'	4719828-S	1079.00	4733328-S	1043.00	4718528-S	689.00	4730628-S	651.00	
EXTRA-WIDE SINGLE SLIDING DOORS—FULL PARTITION HEIGHT (no transoms)									
Overall Ht.	8' WIDE				10' WIDE				
	7'	4733828-S	1046.00	4734528-S	988.00	4734128-S	1144.00	4735028-S	1106.00
	8'	4719728-S	1103.00	4734628-S	1065.00	4734228-S	1256.00	4735128-S	1217.00
	9'	4733928-S	1214.00	4734728-S	1181.00	4734328-S	1365.00	4735228-S	1322.00
10'	4719928-S	1286.00	4734828-S	1255.00	4720028-S	1454.00	4735328-S	1416.00	

B. Hinged Doors

Can be hinged on left or right; set to open in or out. Openings are 7' high with transom filling out the panel height of 8', 9' and 10' door.

Overall WxH	Cyl. Locks, Keys		w/Padlock Lugs	
	Stock No.	\$	Stock No.	\$
HINGED SINGLE DOORS				
3x7'	4720628-S	333.00	4708128-S	296.00
4x7'	4720728-S	378.00	4708228-S	340.00
3x8'	4720828-S	380.00	4708328-S	341.00
4x8'	4720928-S	430.00	4708428-S	398.00
3x9'	4720228-S	433.00	4708528-S	396.00
4x9'	4720328-S	457.00	4708628-S	423.00
3x10'	4722128-S	414.00	4708728-S	378.00
4x10'	4722628-S	471.00	4708828-S	430.00
HINGED DOUBLE DOORS two stiffener posts and angle header strikes. No transom.				
6x7'	4725028-S	739.00	4726028-S	705.00
8x7'	4725128-S	802.00	4726128-S	761.00
6x8'	4725228-S	775.00	4726228-S	740.00
8x8'	4725328-S	855.00	4726328-S	820.00
6x9'	4725428-S	869.00	4726428-S	833.00
8x9'	4725528-S	953.00	4726528-S	916.00
6x10'	4725628-S	941.00	4726628-S	901.00
8x10'	4725728-S	1033.00	4726728-S	995.00

Call for these products and MORE!



HUSKY Windows for Partition System

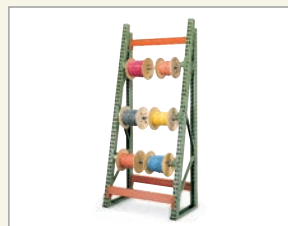

HUSKY Reel Rack



COFFING Heavy-Duty Hoists

Ships same day for 1-3 day delivery

Ships 1-5 days

TURN UP THE VOLUME

SPACE-SAVING BULK CONTAINMENT SYSTEMS



Shown:
3527602-V
container
with lid.

Relius solutions Collapsible Wire Containers

- Steel wire • 4-way fork access • Stackable

High-strength, lightweight containers add less weight to shipping costs. Welded, square mesh wire. Include half-drop side gates and caster pads. 4" underclearance. **IN STOCK.**

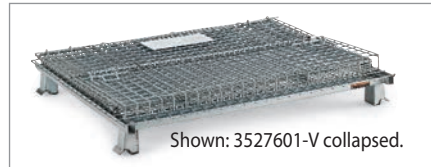

Shown: 3527601-V collapsed.



3527501-V shown with optional casters.



3527401-V

3527301-V

Collapsible Wire Containers with Zinc-Plated Finish

Optional casters sold separately. *Specify: (01) container only, (02) container with lid.*

Overall WxLxH	Cap. Lbs.	Cap. Cu. Ft.	Inside Height	Collapsed Height	Drop Gate Side	Mesh Size	Mesh Gauge	CONTAINER		CONTAINER WITH LID	
								Stock Number	\$	Stock Number	\$
32x20x21"	1500	5.2	15.88"	6 1/2"	32"	1 7/8x1"	5	3527301-V	96.90	—	—
32x20x21"	1500	5.2	15.88"	6 1/2"	32"	1x1"	5	3527401-V	116.00	—	—
40x32x33 1/2"	4000	19.8	28.19"	8 1/4"	40"	2"	3	3527501-V	178.00	3527502-V	207.00
48x40x35"	4000	30.8	29.78"	8 1/4"	48"	2"	3	3527601-V	239.00	3527602-V	278.00
48x40x39 1/2"	4000	38.3	34.14"	8 1/4"	48"	2"	3	3527701-V	255.00	3527702-V	299.00

3527800-V Optional 4x2" phenolic casters. \$69.60

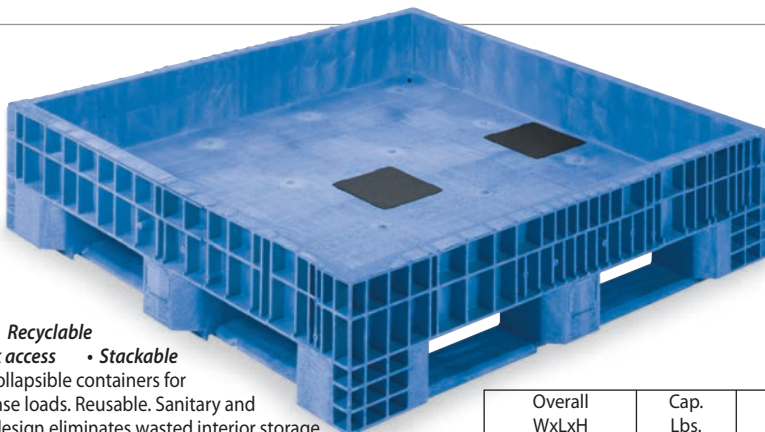

BUCKHORN Transport Tubs

- Structural foam • Recyclable
- 2-way and 4-way fork access • Stackable

Solid, one-piece, non-collapsible containers for transporting heavy, dense loads. Reusable. Sanitary and washable. Low-profile design eliminates wasted interior storage space. Steel runner on base. Four-way fork access. Color: blue.

Made in USA. **SELECTED MODELS IN STOCK. Others FACTORY QUICK SHIP.**



Overall WxLxH	Cap. Lbs.	Cap. Cu. Ft.	Inside Height	Stock Number	\$
48x45x12"	2300	5.5	5.2"	4742700-S	368.00
48x45x19"	2300	13	12.2"	4774500-S	453.00

Call for more options!



BUCKHORN Maximizer™ Collapsible Bulk Container

- Injection-molded polypropylene and polyethylene
- Recyclable • 4-way forklift access • Stackable

Ideal for manufacturing, durable foods, and packaging products, the Maximizer container features a unique collapsible design that allows one person to quickly set up or break down. Integrated sidewalls, lid, and pallet base fold flat in seconds. Special interlocking system does not require special tools, staples, or nails to assemble. Dual drop-down doors offer ergonomic access to stored contents. Moisture-resistant plastic material withstands outdoor use. Made in USA. *IN STOCK.*

Complete unit includes sidewalls, pallet base and lid.



Overall WxLxH	Cap. Lbs.	Cap. Cu. Ft.	Inside Height	Collapsed Height	Access Door Side	Stock Number	\$
48x40x42.6"	800	35	36"	11"	On 48" sides	7896500-S	337.00



Optional snap-in card holder.

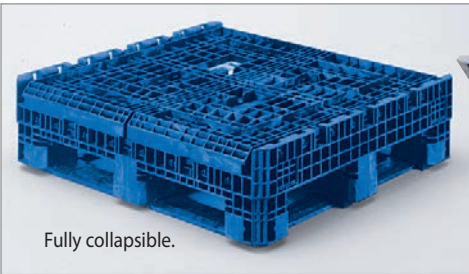

ORBIS™

Medium-Duty Collapsible Bulk Containers

- Structural foam • Recyclable • 4-way fork access • Stackable

Large, easy-to-use snap lock latches ease container collapse. Molded area on all sides accepts optional snap-in card holders. Blue bulk containers have been approved to meet FDA standards. Made in USA. *SELECTED MODELS IN STOCK. Others FACTORY QUICK SHIP.*



4674729-U with
(2) 4644200-U snap-in cardholders

Overall WxLxH	Cap. Lbs.	Cap. Cu. Ft.	Inside Height	Collapsed Height	Access Door Side	BLUE		BLACK	
						Stock No.	\$	Stock No.	\$
32x30x25"	2000	8.1	18.1"	13.1"	On 32" sides	4674118-U	371.00	4674129-U	319.00
48x45x25"	1500	19.3	18.1"	13"	On 48" sides	4674518-U	510.00	4674529-U	435.00
48x45x34"	1500	29	27.1"	13"	—	—	—	4674600-U	445.00
48x45x34"	1500	29	27.1"	13"	On 48" sides	4674718-U	538.00	4674729-U	441.00
48x40x50"	1500	43.4	43.7	17.7"	On 48" sides	—	—	3712229-T	445.00

Accessories For Bulk Containers

4644200-U Snap-In Cardholder. 4.8x8.5". For 4x8.3" cards. \$	1.02
4657600-U Structural Foam Lid. Fits 32x30" containers. \$	118.00
4657700-U Structural Foam Lid. Fits 48x45" containers. \$	125.00

Call for more Bulk Containers and Tilt Trucks



BAYHEAD
Haul-All Tilt Trucks



WESCO
Box Trucks



RUBBERMAID
Structural Foam Tilt Trucks



BAYHEAD
Low-Profile Mobile Hoppers

ON THE MOVE

HIGH QUALITY PALLET TRUCKS & PALLETS



5-year full replacement pump warranty

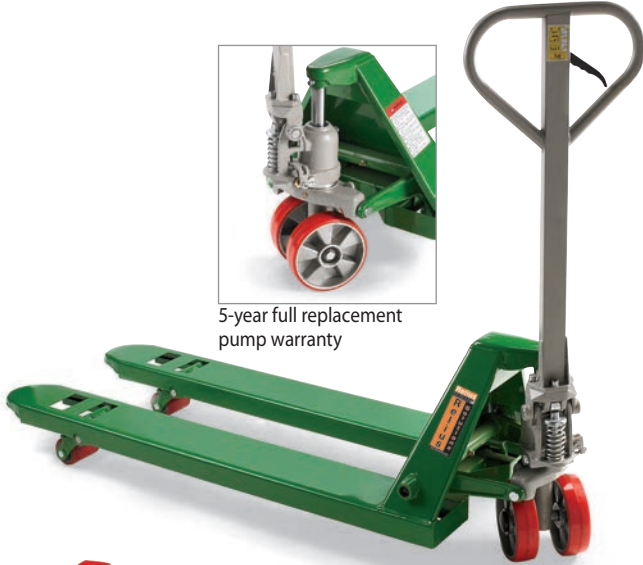

Relius
solutions™

5500-Lb. Capacity Pallet Trucks

- 5-year warranty

Economical pallet truck does all the work of the higher-priced models. Spring-loaded handle has 3-position raise, lower, neutral fingertip control. Green powder coat finish with gray handle and pump. *IN STOCK.*

Fork Width, Overall	Fork Length, Overall	Stock Number	\$
20.5"	48"	6091504-S	301.00
27"	48"	6091508-S	317.00



Handle includes wrap around hand guard, reversing switch, dual butterfly thumb control, and horn.

7683800-S shown



7864900-S shown

Call for many more pallet truck options.

Nationwide Service Network

BIG JOE Basic Series Fully Powered Pallet Trucks

- 3000- and 4500-lb. capacities
- 3" and 3.25" lowered heights
- Three-year warranty

Increase productivity and reduce operator fatigue with this fully powered pallet truck with both motorized travel and lift functions. Ergonomically designed tiller offers dual right- and left-hand controls for travel, lift, and lower functions. Other features include: key switch, horn, battery discharge indicator, reversing switch, hour meter and emergency disconnect. *FACTORY QUICK SHIP.*

WPT45 Pallet Truck

4500-lb. capacity pallet truck moves up to 60 pallets per battery charge. Powered by a 24-volt AC electrical drive system with Curtis controller and 105AH AGM maintenance-free battery pack and 120V AC charger. 6.75" wide forks.

Fork Width, Overall	Fork Length, Overall	Fork Height, Lowered	Fork Height, Raised	Travel Speed Loaded (mph)	Travel Speed No Load (mph)	Stock Number	\$
27"	45.5"	3.25"	8.25"	2.86	3.66	7864900-S	4885.00

E30 Pallet Truck

3000-lb. cap. pallet truck is perfect for confined areas and narrow aisles, compact truck offers exceptional maneuverability. Features a compact power head with high torque 24-volt DC electrical drive system. 65 AH battery pack and 110V AC charger allows truck to move up to 40 pallets per charge. 6" wide forks.

Fork Width, Overall	Fork Length, Overall	Fork Height, Lowered	Fork Height, Raised	Travel Speed Loaded (mph)	Travel Speed No Load (mph)	Stock Number	\$
27"	45"	3"	7.5"	2	2.15	7683800-S	3342.00



Premium Scale Pallet Truck

- 4400-lb. capacity • 3.3" lowered height

Reliable scale features keyboard calibration and functional set-up with automatic zero capabilities. Fingertip lever controls raise, lower and neutral operations. Weighs in pounds or kilograms. Weighing accuracy of +/-1%. Large LCD display uses standard AA battery pack of 4, no charger needed. Polyurethane wheels—(2) 7" steering and (2) 2.7" load wheels. *IN STOCK.*



Weighing Increment	Fork Height, Raised	Fork Width, Overall	Fork Length, Overall	Stock Number	\$
1 lb./0.5 kg	8"	22"	46"	5797404-T	2075.00
1 lb./0.5 kg	8"	27 1/2"	46"	5797408-T	2100.00



Steel cover easily flips open, and protects LCD display when not in use.



ORBIS® Rackstar™ Pallets

- Polyethylene structural foam • Recyclable • Stackable • Rackable

Double-deck, open-grid design is ideal for the food service industry. Available with 1/2" interrupted lip on the top deck. Four-way fork entry. Made in USA. *SELECTED MODELS IN STOCK.*



Overall WxLxH	Description	Floor Cap. Lbs.	Fork Cap. Lbs.	Stock Number	\$
48x40x6.6"	Blue	20000	5000	4421000-V*	241.00
48x40x6.6"	Blue with Lip	20000	5000	4421100-V*	241.00
48x40x6.6"	Black	20000	5000	4421300-V	239.00
48x40x6.6"	Black with Lip	20000	5000	4421400-V	239.00

*100% virgin material with colorants/pigments that have been approved to meet FDA standards.



ORBIS® Double-Deck Pallet

- 100% post-industrial recycled structural foam
- Recyclable • Stackable



Double-deck design permits greater stability and support of heavy loads. Compatible with a broad range of conveyor systems and automated material handling equipment. Four-way fork entry. Not rackable. Made in USA. *IN STOCK.*

Overall WxLxH	Floor Cap. Lbs.	Fork Cap. Lbs.	Stock Number	\$	\$ (20+)
48x40x5.8"	30000	3500	4453400-T	150.00	143.00



ORBIS® Injection Molded Pallets

- 100% post-industrial recycled injection-molded polyethylene
- Recyclable • Nestable



Flow-through design is easy to steam clean. Choose either flat top model or pallet with 1" intermittent lip. Four-way fork entry. Weather-resistant. Pallets are ISPM 15 exempt. Sold in lots of 5, priced each. Color: black. Made in USA. *IN STOCK.*

Type	Overall WxLxH	Floor Cap. Lbs.	Fork Cap. Lbs.	Stock Number	\$ (5+)	\$ (30+)
Flat	48x40x5.5"	11000	2300	4498400-T	41.00	39.00
With lip	48x40x5.5"	11000	2300	4498900-T	45.20	43.00



Call for these Warehouse Products and MORE!



RUBBERMAID Brute Containers



VESTIL Pallet Truck Foot Guard



RUBBERMAID Premium Universal Shelf Carts



WESCO Adjustable-Width Pallet Trucks



VESTIL All-Terrain Pallet Truck

Ships same day for 1-3 day delivery

Ships 1-5 days

SMALL STORAGE AREA



SECTIONAL INDEX

Bins.....16-17
 Bins & Bin Racks.....18-19
 Bin Cabinets & Storage Cabinets.....20-21
 Steel Shelving.....22-23
 Wire Shelving.....24-25

Small items can be a big deal. From poly bins to cabinets, find everything you need to conveniently store the smallest parts. Injection-molded plastics with multiple storage options, secure cabinets, and easily accessible racks and shelves enhance your workflow to help better organize your warehouse. Make storing small parts quicker and easier by calling for information.

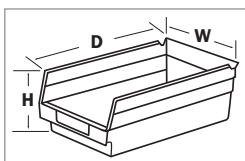

Overall WxDxH	Inner Bin Capacity 42893 42894	Ctn. Qty.	Stock Number	\$	\$ (4+ Ctn.)
4"H BINS.					
Specify color: (02) red, (09) yellow, (12) green, (18) blue, (22) ivory.					
2 ³ / ₈ x11 ⁵ / ₈ x4"	3/0	36	42731-S	1.62	1.54
4 ¹ / ₈ x11 ⁵ / ₈ x4"	6/2	36	42732-S	1.64	1.56
6 ⁵ / ₈ x11 ⁵ / ₈ x4"	9/4	30	42733-S	2.02	1.92
8 ³ / ₈ x11 ⁵ / ₈ x4"	12/4	20	42734-S	2.94	2.80
11 ¹ / ₈ x11 ⁵ / ₈ x4"	18/6	8	42739-S	4.26	4.05
4 ¹ / ₈ x17 ⁵ / ₈ x4"	9/3	20	42740-S	2.49	2.37
6 ⁵ / ₈ x17 ⁵ / ₈ x4"	15/6	20	42741-S	3.26	3.10
8 ³ / ₈ x17 ⁵ / ₈ x4"	19/6	10	42742-S	3.93	3.74
11 ¹ / ₈ x17 ⁵ / ₈ x4"	29/8	8	42743-S	6.90	6.60
4 ¹ / ₈ x23 ⁵ / ₈ x4"	13/4	16	42762-S	3.92	3.73
6 ⁵ / ₈ x23 ⁵ / ₈ x4"	12/8	8	42764-S	4.49	4.27
8 ³ / ₈ x23 ⁵ / ₈ x4"	24/8	6	42771-S	8.70	8.30
11 ¹ / ₈ x23 ⁵ / ₈ x4"	35/16	6	42772-S	8.80	8.40
6"H BINS.					
Specify color: (02) red, (09) yellow, (18) blue.					
4 ¹ / ₈ x11 ⁵ / ₈ x6"	6/2	36	49708-S	2.66	2.53
6 ⁵ / ₈ x11 ⁵ / ₈ x6"	9/4	30	49709-S	4.04	3.84
8 ³ / ₈ x11 ⁵ / ₈ x6"	12/4	20	53747-S	4.90	4.66
4 ¹ / ₈ x17 ⁵ / ₈ x6"	9/3	20	49722-S	3.79	3.61
6 ⁵ / ₈ x17 ⁵ / ₈ x6"	15/6	20	49723-S	5.10	4.85
8 ³ / ₈ x17 ⁵ / ₈ x6"	19/6	10	53748-S	7.40	7.10
4 ¹ / ₈ x23 ⁵ / ₈ x6"	13/4	16	53756-S	7.90	7.60
6 ⁵ / ₈ x23 ⁵ / ₈ x6"	12/8	8	53768-S	10.80	10.30



Shelf Bins

- Quick access & easy organization of small parts
 - Polypropylene • Nestable
- Line standard 12", 18", or 24"D shelving with durable shelf bins. Other features include reinforced side ribs and slotted label holder. Dividers and bin cups sold separately. Order bins in quantities specified, priced each. Made in USA. *IN STOCK.*

Dividers. Sold in quantities of 50 only. Color: black.

Fits Bin	Stock No.	\$	\$ (4+)
DIVIDERS FOR 4"H BINS			
4 ¹ / ₈ "W	4278300-S	23.20	22.10
6 ⁵ / ₈ "W	4278400-S	27.00	25.70
8 ³ / ₈ "W	4279300-S	43.40	41.30
11 ¹ / ₈ "W	4279400-S	63.70	60.60
DIVIDERS FOR 6"H BINS			
4 ¹ / ₈ "W	3200300-V	53.00	50.40
6 ⁵ / ₈ "W	3200400-V	57.70	54.90
8 ³ / ₈ "W	3200500-V	135.00	129.00
11 ¹ / ₈ "W	3200600-V	157.00	150.00

Inner Bins. Sold in carton quantities of 48 only.

Overall WxDxH	YELLOW		BLUE	
	Stock No.	Stock No.	\$ Ctn.	\$ (4+)
3 ¹ / ₈ x1 ¹ / ₈ x3"	4289309-S	4289318-S	19.80	18.90
5 ¹ / ₈ x2 ¹ / ₈ x3"	4289409-S	4289418-S	34.10	32.40

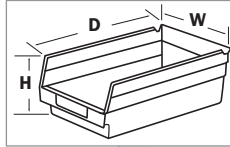
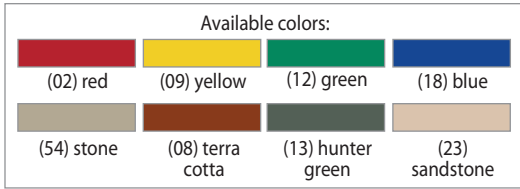

NEW
COLORS

AKRO-MILS Small Parts Shelf Bins

- Keeps small parts neatly organized
 - Industrial-grade polymer
 - Nestable
- Fit on 12", 18", and 24" deep shelving. Rear lip suspends bin from shelf above. Dividers and bin cups sold separately. Order in carton quantities specified, priced each. Made in USA. Specify color: (02) red, (09) yellow, (12) green, (18) blue, (54) stone. **IN STOCK.** (08) terra cotta, (13) hunter green, (23) sandstone also available in select sizes.

SHIPS SAME DAY!



Overall WxDxH	Inner Bin Capacity	Ctn. Qty.	(02), (09), (12), (18), (30) Stock Number	(08), (13), (23) Stock Number	\$	\$ (4+ Ctn.)	Stock Number	\$ Pkg.
BINS								
2 3/4" x 11 5/8" x 4"	3	24	44068-T	—	1.32	1.26	—	—
4 1/8" x 11 5/8" x 4"	5	24	44072-5	44072-T	1.52	1.45	4407100-T	14.10
6 5/8" x 11 5/8" x 4"	9	12	44069-T	44069-T	2.32	2.21	4407000-T	15.10
8 3/8" x 11 5/8" x 4"	11	12	44090-T	—	2.49	2.37	4410400-T	34.10
11 1/8" x 11 5/8" x 4"	15	12	44101-T	—	3.64	3.46	4404300-T	42.40
4 1/8" x 17 1/8" x 4"	8	12	44080-T	44080-T	2.01	1.91	4407100-T	14.10
6 5/8" x 17 1/8" x 4"	15	12	44081-T	44081-T	2.86	2.72	4407000-T	15.10
8 3/8" x 17 1/8" x 4"	18	12	44092-T	—	3.88	3.69	4410400-T	34.10
11 1/8" x 17 1/8" x 4"	25	12	44111-T	—	6.60	6.30	4404300-T	42.40
4 1/8" x 23 3/8" x 4"	11	12	44095-T	44095-T	3.88	3.69	4407100-T	14.10
6 5/8" x 23 3/8" x 4"	21	6	44096-T	44096-T	5.80	5.60	4407000-T	15.10
8 3/8" x 23 3/8" x 4"	25	6	44124-T	—	7.70	7.40	4410400-T	34.10
11 1/8" x 23 3/8" x 4"	35	6	44126-T	—	8.50	8.10	4404300-T	42.40

4408700-T Inner Bins. 3 1/4" x 2 x 3" H. \$ 0.67. \$ (4+ ctn.)0.64

AKRO-MILS Super-Size AkroBins®

- Easily store and move bulky items
 - Industrial-grade polymer
 - Stackable
- Reinforced sides, extra-large front label area, and molded-in rear carrying handle. Not recommended for hanging systems. Solid steel dolly holds 500 lbs. and includes (4) 2" bolted-on polyolefin swivel casters. Gray powder coat finish. Order bins in carton quantities specified, priced each. Made in USA. **SELECTED MODELS IN STOCK.**

SHIPS SAME DAY!



Overall WxDxH	Ctn. Qty.	BINS			\$	\$ (4+ Ctns.)	DOLLIES	
		RED	YELLOW	BLUE			Stock Number	\$
		Stock No.	Stock No.	Stock No.				
11x23 7/8x7"	4	3699202-V	3699209-V	3699218-V	21.70	20.70	—	—
11x23 7/8x10"	4	3699302-V	3699309-V	3699318-V	31.40	29.90	—	—
11x29 7/8x10"	4	3699602-V	3699609-V	3699618-V	36.30	34.50	—	—
12 3/8x20x6"	4	4262802-U	—	4262818-U	20.90	19.90	4261300-U	65.60
12 3/8x20x8"	3	4263102-U	4263109-U	4263118-U	23.20	22.10	4261300-U	65.60
12 3/8x20x12"	2	4263202-U	4263209-U	4263218-U	28.40	27.00	4261300-U	65.60
16 1/8x23 7/8x11"	1	—	—	3699418-V	42.70	40.60	—	—
16 1/8x29 7/8x11"	1	—	3699709-V	3699718-V	50.70	48.20	—	—
18 3/8x20x12"	1	4263302-U	4263309-U	4263318-U	34.10	32.40	4261300-U	65.60
18 3/8x23 7/8x12"	1	3699502-V	—	3699518-V	45.10	42.90	—	—
18 3/8x29 7/8x12"	1	4263402-U	4263409-U	4263418-U	48.70	46.30	4266700-U	75.50

Ships same day for 1-3 day delivery

Ships 1-5 days

KEEP PARTS WITHIN REACH

CONVENIENT & DURABLE BINS, BIN RACKS

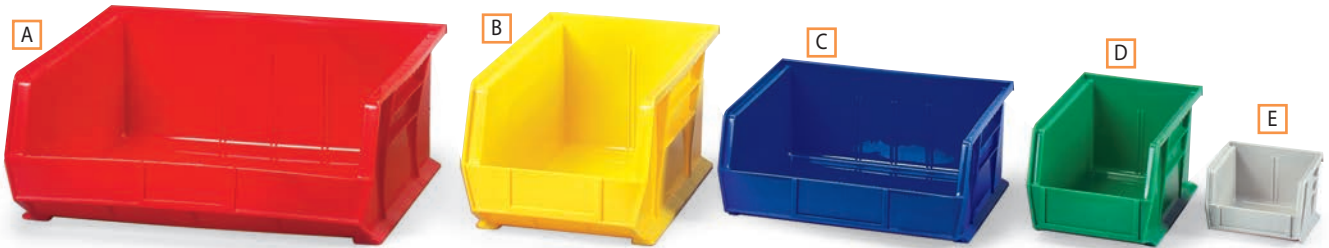

AKRO-MILS
by **AkroBins®**

SHIPS SAME DAY!

- Optimize and organize your storage space
- Industrial-grade polymer
- Stackable

Guaranteed not to break! Feature reinforcing ribs and include rear hanger lip for racking. Waterproof and resistant to oil and chemicals. Sold in carton quantities, priced each. Made in USA. Specify color: (02) red, (09) yellow, (12) green, (18) blue, (54) stone. *IN STOCK.*

Key	Overall WxDxH	Ctn. Qty.	Stock Number	\$	\$ (4+)
A	16 1/2"x14 1/2"x7"	6	52023-U	16.40	15.60
B	8 1/2"x14 1/2"x7"	12	52028-U	11.90	11.40
B	8 1/2"x10 1/2"x7"	6	52029-U	8.50	8.10
C	11x10 1/2"x5"	6	52030-U	9.20	8.80
D	5 1/2"x10 1/2"x5"	12	52031-U	5.10	4.85
E	4 1/2"x7 1/2"x3"	24	52032-U	2.11	2.01
E	4 1/2"x5 1/2"x3"	24	52060-U	1.30	1.24

Louvered Panel Systems

Choose floor, bench or wall-mount style AKRO-MILS® panels. Louvers securely support bins. 16-ga. steel panels are reinforced with horizontal ribs. Durable gray powder coat finish. Made in USA. *IN STOCK.*

SHIPS SAME DAY!

QUANTITY OF SAME SIZE BINS THAT FIT PANELS OR RACKS					
Combined	52028-U			52032-U	
Panel Size	52023-U	52029-U	52030-U	52031-U	52060-U
(G) 1 Panel, 18x19"	2	4	3	9	16
(G) 1 Panel, 35 1/2"x19"	4	8	9	18	32
(H) 1 Rack, 18x61"	6	12	14	28	48
(H) 1 Rack, 36x61"	12	24	28	54	96

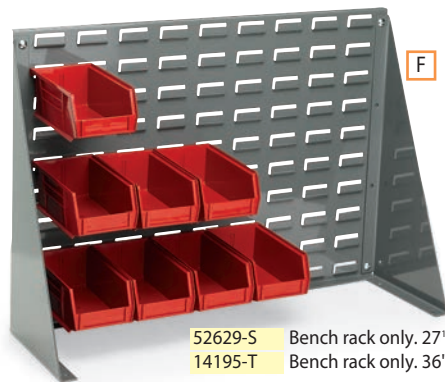

F

F. Bench Rack

- 120-lb. capacity
- Bins hang on one side

Includes RELIUS SOLUTIONS bins. Specify bin color: (02) red, (09) yellow, (18) blue.

52629-S Bench rack only. 27 1/2"Wx8"Dx21"H \$52.30
 14195-T Bench rack only. 36"Wx8"Dx21"H. \$96.00

Overall WxDxH	Bin Qty.	Bin WxDxH	Stock Number	\$
27 1/2"x8x21"	24	4 1/2"x5 1/2"x3"	52852-S	69.10
27 1/2"x8x21"	24	4 1/2"x7 1/2"x3"	52853-S	77.40
27 1/2"x8x21"	12	5 1/2"x10 1/2"x5"	52854-S	87.80



H

H. Floor Rack

- 350- and 500-lb. capacities
- Bins hang on one side

Bins sold separately.

Overall WxH	Cap. Lbs.	Stock Number	\$
18x61"	350	5189400-S	249.00
36x61"	500	5189500-S	359.00

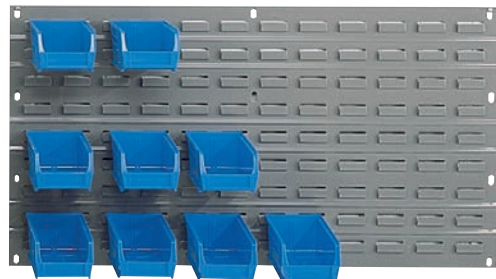

G

G. Wall-Mount Panel

- 160-lb. capacity
- Bins hang on one side

1/4" thick louvered steel panel. Bins sold separately.

Overall WxH	BEIGE	GRAY	\$
	Stock No.	Stock No.	
18x19"	3699922-T	3699927-T	24.00
35 1/2"x19"	4468922-T	4468927-T	32.90

CALL TO ORDER ADDITIONAL RACKS WITH INDUSTRIAL-GRADE POLYMER BINS



Call to order additional industrial-grade polymer bin racks



Benchtop rack

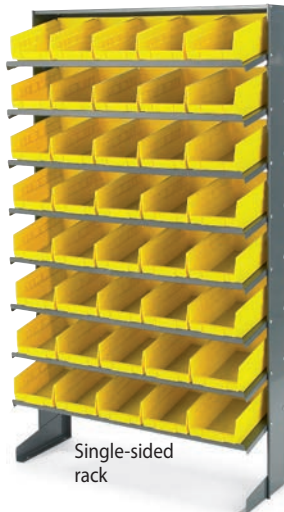

Single-sided rack

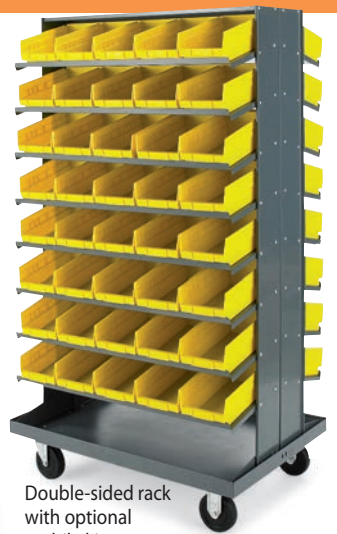

Double-sided rack with optional mobile kit.

Pick Racks

• *Single- and double-sided models available*
Steel racks come complete with removable polypropylene shelf bins. Bins sit on angled shelves for easier access. Specify bin color: (02) red, (09) yellow, (12) green, (18) blue, (22) ivory. **IN STOCK.**



Description	Overall WxDxH	Bin Qty.	Bin WxDxH	Stock Number	\$
Double-sided rack	36x24x64"	80	6 ⁵ / ₈ x11 ⁵ / ₈ x4"	52438-U	746.00
Single-sided rack	36x12x60"	40	6 ⁵ / ₈ x11 ⁵ / ₈ x4"	52434-U	377.00
Benchtop rack	36x12 ¹ / ₂ x23"	15	6 ⁵ / ₈ x11 ⁵ / ₈ x4"	52416-U	157.00

52486-U Mobile Kit for Double-Sided Rack. (4) 3" poly swivel casters, 2 with brake.
\$164.00

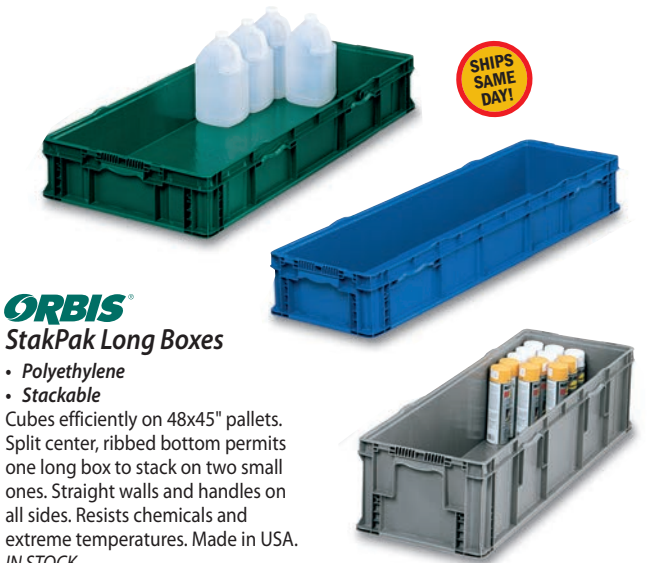

ORBIS StakPak Long Boxes

• *Polyethylene*
• *Stackable*
Cubes efficiently on 48x45" pallets. Split center, ribbed bottom permits one long box to stack on two small ones. Straight walls and handles on all sides. Resists chemicals and extreme temperatures. Made in USA. **IN STOCK.**

Overall LxWxH	Cap. Cu. Ft.	GREEN Stock No.	BLUE Stock No.	GRAY Stock No.	\$
48x15x7 ¹ / ₂ "	2.3	5400112-T	5400118-T	5400127-T	58.50
48x15x11"	3.5	5400212-T	5400218-T	5400227-T	64.20
48x22 ¹ / ₂ x7 ¹ / ₄ "	3.5	5401512-T	5401518-T	5401527-T	111.00



Shelves attach with double rivets for quick assembly.



Gravity Flow Shelving

• *Shelf capacity: 500 lbs., capacity based on evenly distributed loads*
• *Unassembled—no hardware needed*
May be placed side-by-side or front-to-back to create a large storage system. Shelves feature 2" side shelf flanges and 1/2" front lip to retain contents. Heavy-duty shelf supports attach with double rivets—need only a rubber mallet to install in minutes. Includes shelves and front-to-back supports at top and bottom. Gray baked enamel finish. Made in USA. **IN STOCK.**



Overall WxDxH	Shelf Cap. Lbs.	Slanted Shelf Qty.	Flat Shelf Qty.	STARTER UNITS		ADD-ON UNITS	
				Stock No.	\$	Stock No.	\$
36x18x84"	500	5	1	5772900-S	208.00	5773300-S	203.00
36x24x84"	500	5	1	5773000-S	231.00	5773400-S	227.00
48x18x84"	500	5	1	5773100-S	238.00	5773500-S	233.00
48x24x84"	500	5	1	5773200-S	272.00	5776900-S	267.00

Call for more Small Storage and Tool Storage products!



AKRO-MILS Akro-Grid Dividable Containers



ROUSSEAU Standard-Width Drawer Cabinets



STRONGHOLD Ultra-Capacity Combination Cabinets



WATERLOO 3-Drawer Project Center

Ships same day for 1-3 day delivery

Ships 1-5 days

PROTECT & ORGANIZE

WITH VERSATILE BIN & STORAGE CABINETS



Relius
solutions

Ultra Deep-Door Security Bin Cabinets

- 14-gauge steel
- All-welded
- Padlock hasp with single-point lock

High-density storage cabinets feature 4"D pocket doors, adjustable leveling feet, and a high-security hasp. Unbreakable polypropylene bins are guaranteed for life. Cabinet holds: (48) 5³/₈"Lx4¹/₈"Wx3"H, (48) 7³/₈"Lx4¹/₈"Wx3"H, (12) 14³/₄"Lx8¹/₄"Wx7"H, (18) 10⁷/₈"Lx5¹/₂"Wx5"H, and (6) 14³/₄"Lx16¹/₂"Wx7"H bins. Gray enamel finish. Made in USA. *IN STOCK.*

Description	Overall WxDxH	Stock Number	\$
Cabinet with 132 Yellow Bins.	36x24x72"	8500127-T	1445.00
Cabinet with 132 Blue Bins.	36x24x72"	8505227-T	1445.00
Cabinet with bin slots only.	36x24x72"	8520027-T	967.00



HIGH-SECURITY HASP! Specially designed hardened steel hasp keeps the entire lock out of the reach of bolt cutters and other cutting devices.

CALL FOR MORE DESIGN CONFIGURATIONS.



Relius
solutions

Deep-Door Security Cabinets

- 800-lb. capacity per shelf
- 16-gauge steel
- All-welded
- Padlock hasp with single-point lock

"Universal," all-in-one, premium-series cabinets store all your tools and supplies. High-security padlock hasp prevents cutting devices from reaching lock. 30¹/₂"Wx16⁷/₈"Dx4"H, 75-lb. capacity drawers have 100% full-extension ball-bearing glides. Drawers may be divided into (16) 4x7¹/₂" compartments with removable dividers provided. Removable Akro-Bins® hang from louvered panels. Made in USA. *IN STOCK.*

Four-Drawer Cabinet with 118 Bins

Includes the following bins: (96) 5³/₈"Lx4¹/₈"Wx3"H; (18) 10⁷/₈"Lx5¹/₂"Wx5"H; (4) 14³/₄"Lx8¹/₄"Wx7"H.

Overall WxDxH	Stock No.	\$
36x24x72"	8414200-V	3381.00





Storage Cabinets

- 225-lb. capacity per shelf
- 16–22-gauge cabinet; 20-gauge steel shelves
- Unassembled and set-up
- Three-point lock

Welded frames prevent doors from sagging, while the concealed hinges offer a clean look. Other features include adjustable shelves (2" centers), chrome handles, and enclosed bases. Tough powder coat finish. Made in USA. **SELECTED MODELS IN STOCK.**

Extra Shelves

Specify color: (23) tan, (27) gray, (29) black.

41968-S	36"Wx18"D.	\$	23.50
41969-S	36"Wx24"D.	\$	28.10
52958-S*	48"Wx18"D.	\$	38.00
52716-S*	48"Wx24"D.	\$	45.50

*Not available in black.



Overall WxDxH	Shelf Openings	TAN	GRAY	BLACK	\$	TAN	GRAY	BLACK	\$
		Stock No.	Stock No.	Stock No.		Stock No.	Stock No.	Stock No.	
UNASSEMBLED					SET-UP				
36x18x42"	3	4197623-S	4197627-S	4197629-S	226.00	—	—	—	—
36x24x42"	3	4197723-S	4197727-S	4197729-S	251.00	—	—	—	—
36x18x78"	5	4196623-S	4196627-S	4196629-S	229.00	4195023-S	4195027-S	4195029-S	277.00
36x24x78"	5	4196723-S	4196727-S	4196729-S	276.00	4195123-S	4195127-S	4195129-S	308.00
48x18x78"	5	5281823-S	5281827-S	—	326.00	—	—	—	—
48x24x78"	5	5271323-S	5271327-S	—	350.00	—	—	—	—



Wall-Hung Cabinets

- Up to 180-lb. capacity per shelf, capacities based on evenly distributed loads
- 22-gauge steel • 3 shelf openings • Set up
- Single-point lock (single-door cabinets); three-point lock (double-door cabinets)

Keep floor space clear and eliminate clutter on your desktop. Include adjustable shelves perfect for spray cans, first aid supplies, cleaners, or other light-duty supplies. Key lock handles secure stored items. Some assembly required for handle. Durable finish. Made in USA. **IN STOCK.**



Overall WxDxH	Shelf Cap. Lbs.	Door Qty.	PUTTY	DARK GRAY	\$
			Stock No.	Stock No.	
18x12x26"	85	1	4787521-S	4787528-S	201.00
30x12x30"	150	2	4787021-S	4787028-S	257.00



Call for these products and MORE!



STRONG HOLD Clear-View Wardrobe Cabinets



PARENT METAL Heavy-Duty Visual Cabinets



TENNSCO Sliding Door Storage Cabinets



Additional SANDUSKY LEE Wall-Hung Cabinets

Ships same day for 1-3 day delivery

Ships 1-5 days

CONFIGURE TO YOUR UNIQUE NEEDS

CUSTOMIZABLE STORAGE SHELVING

SHIPS SAME DAY!



48"Wx24"Dx85"H,
5-shelf starter shown.



Oversized welded foot plate provides additional stability.



Shelves are reinforced with full-length welded box channels.



Extra Ultra-Capacity Shelf Clips with 2-point suspension. Locking feature reinforces corners to reduce lateral movement. Once the clip and shelf are in place, the corner becomes completely closed. 3023300-S \$0.62

Relius Reinforced Shelving

- **Heavy-Industrial:** 14-gauge steel uprights; 20-gauge steel shelves
- **Shelves connect to posts via ultra-capacity shelf clips with wedge-type grips**
- **Shelf capacity: up to 1300 lbs., capacities based on evenly distributed loads**

Shelves feature welded tubular box on front and rear edges as well as lapped and welded corners for maximum strength. Full-length 20-gauge welded box channels mounted on undersides of shelves greatly increases capacity and strength. Posts are punched on 1" centers and include 14-gauge welded foot plates, each with one mounting hole. Begin with starter units and use add-ons as needed to complete rows. Made in USA. **IN STOCK.**



Overall WxDxH	Shelf Cap. Lbs.	Shelf Qty.	STARTER UNITS	
			Stock No.	\$
36x12x85"	1200	5	3003100-T	166.00
36x18x85"	1250	5	3003200-T	195.00
36x24x85"	1300	5	3003300-T	225.00
48x12x85"	780	5	3003400-T	197.00
48x18x85"	800	5	3003500-T	227.00
48x24x85"	900	5	3003600-T	259.00

CALL FOR ADD-ONS AND EXTRA SHELVES.

SHIPS SAME DAY!



5-shelf open-style starter and add-on units shown, each with 1 extra shelf.



14-ga. box-formed post cuts assembly time when connecting two or more units. Punched on 1" centers.

Open Starter includes: (2) angle posts, (2) front box posts, (2) pairs of side braces, (1) pair of back braces, (5) shelves with clips



Open Add-On includes: (1) front box post, (2) rear angle posts, (1) pair of side cross braces, (1) pair of back cross braces, (5) shelves with clips

edsal Premium Shelving

- **Heavy-Industrial:** 14-gauge steel uprights; 20-gauge steel shelves
- **Shelves connect to posts via shelf clips with wedge-type grips**
- **Shelf capacity: up to 1100 lbs., capacities based on evenly distributed loads with a 1.45 safety factor**

Common front box posts cut assembly time when connecting two or more units. Shelves feature welded tubular box on front and rear edges as well as lapped and welded corners for extra strength. Posts are punched on 1" centers. Begin with starter units and use add-ons as needed to complete rows. Made in USA. **IN STOCK.**

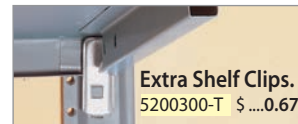

Extra Shelf Clips.
5200300-T \$0.67

20-gauge box shelf with lapped and welded corners provides greater strength for maximum load capacity.

Overall WxDxH	Shelf Cap. Lbs.	Shelf Qty.	STARTER UNITS		ADD-ON UNITS		EXTRA SHELVES	
			Stock No.	\$	Stock No.	\$	Stock No.	\$
36x12x85"	1000	5	5230000-T	141.00	5206100-T	110.00	5126900-T	13.40
36x18x85"	1050	5	5230400-T	146.00	5229400-T	125.00	5127100-T	15.90
36x24x85"	1100	5	5231000-T	170.00	5247600-T	147.00	5127200-T	19.90
48x12x85"	650	5	5231400-T	148.00	5249000-T	131.00	5127300-T	16.20
48x18x85"	675	5	5232300-T	170.00	5250600-T	147.00	5127900-T	20.20
48x24x85"	750	5	5232700-T	202.00	5253100-T	177.00	5128500-T	26.90

CALL FOR CLOSED-STYLE SHELVING.

Move heavy file boxes with a RELIUS SOLUTIONS Polyethylene Dolly, call for information.



T-Post (add-on units)



End Post (starter units)



3964800-U shown with (40) 3955400-W boxes.



Record Storage

- $\frac{5}{8}$ " particleboard decking
- Holds up to 80 file boxes
- Shelf capacity: up to 2250 lbs., shelf capacities based on evenly distributed loads

Shelves attach to posts via a boltless double-rivet connection. Shelves adjust in $1\frac{1}{2}$ " increments. 14-gauge steel uprights. File boxes sold separately. Color: sand. Made in USA. **FACTORY QUICK SHIP.**

File Boxes. IN STOCK.

- 3955400-W 12"Wx15"Dx10 $\frac{1}{4}$ "H. 10/pkg.
\$ Pkg.63.90
- 3965500-W 12 $\frac{1}{4}$ "Wx24 $\frac{1}{2}$ "Dx10 $\frac{1}{4}$ "H. 6/pkg.
\$ Pkg.69.60

Overall WxDxH	Shelf Cap. Lbs.	Shelf Qty.	STARTER		ADD-ON	
			Stock Number	\$	Stock Number	\$
42x15x60"	2250	3	3963000-U	141.00	3963100-U	132.00
42x24x60"	2250	3	3963200-U	165.00	3963300-U	156.00
42x30x60"	2250	3	3963400-U	177.00	3963500-U	168.00
69x15x60"	1800	3	3963600-U	190.00	3963700-U	187.00
69x24x60"	1800	3	3963800-U	259.00	3963900-U	248.00
69x30x60"	1800	3	3964000-U	262.00	3964100-U	255.00

Overall WxDxH	Shelf Cap. Lbs.	Shelf Qty.	STARTER		ADD-ON	
			Stock Number	\$	Stock Number	\$
42x15x84"	2250	4	3964200-U	186.00	3964300-U	180.00
42x24x84"	2250	4	3964400-U	216.00	3964500-U	209.00
42x30x84"	2250	4	3964600-U	232.00	3964700-U	227.00
69x15x84"	1800	4	3964800-U	255.00	3964900-U	247.00
69x24x84"	1800	4	3965000-U	343.00	3965100-U	332.00
69x30x84"	1800	4	3965200-U	353.00	3965300-U	338.00

Call for these shelving options and MORE!



EDSAL Premium Shelving - Closed Style



RELIUS SOLUTIONS Double-Rivet Storage Shelving



QUANTUM Double-Rivet Shelving with Hulk Bins



HALLOWELL Rivetwell Double-Rivet Shelving



RELIUS SOLUTIONS Reinforced Shelving and Add-on Units

Ships same day for 1-3 day delivery

Ships 1-5 days

LIGHTWEIGHT WIRE, HEAVY-DUTY SUPPORT

CLEAN, VENTILATED & FIRE SAFE WIRE SHELVING!



Relius
solutions

SHIPS
SAME
DAY!

Wire Gravity Flow Shelving

- Shelf capacity: 600 lbs., capacity based on evenly distributed loads
- Unassembled—no hardware needed

For continuous replenishment of stock items or assembly parts. 35° slope on slanted shelves. Chrome 1" dia. wire posts with adjustable level glides. Shelf collar slides over sleeves. Create your own custom gravity-flow shelving by adding extra shelves or dividers. *IN STOCK.*



Shelves
Chrome with 1" dia. collars.

Slant shelves feature a generous lip to keep contents in place.

Two 48"Wx24"Dx72"H units shown clamped together. One unit shown with four optional dividers.

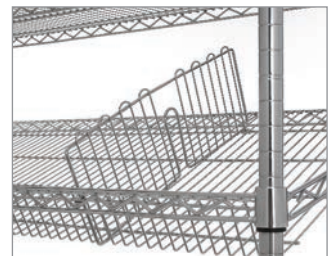

6 1/4"H Shelf Dividers
Chrome.

Overall WxDxH	Shelf Cap. Lbs.	COMPLETE UNITS			EXTRA SHELVES		
		Slanted Shelf Qty.	Flat Shelf Qty.	Stock Number	\$	Stock Number	\$
36x18x72"	600	4	1	6034500-T	221.00	6034900-T	48.90
48x18x72"	600	4	1	6034600-T	272.00	6035000-T	63.90
60x18x72"	600	4	1	6034700-T	371.00	6035100-T	87.00
72x18x72"	600	4	1	6034800-T	440.00	6035200-T	108.00
36x24x72"	600	4	1	5688400-U	296.00	6035300-T	66.50
48x24x72"	600	4	1	5688500-U	377.00	6035400-T	105.00
60x24x72"	600	4	1	5688600-U	446.00	6035500-T	116.00
72x24x72"	600	4	1	5688700-U	537.00	6035600-T	139.00

Fits Shelf Depth	Overall Width	Stock Number	\$
18"	14 1/4"	6035800-T	11.60
24"	17 7/8"	6035900-T	13.10

ADDITIONAL COMPONENTS AVAILABLE, CALL FOR INFORMATION.



Post Sleeves

Snap into place. Pkg. of 4.

5681600-T \$ Pkg.2.85



Post Clamps

Join shelving units together for maximum strength.

5681700-W \$3.81



High-Capacity S-Hooks

Provides connection between starter and add-on shelves. Use two per shelf.

5877700-T \$1.89



Wire Shelving

- Shelves slide over split sleeves along grooved 1" dia. posts
- 2-piece post on 63", 72" or 86"H posts
- Up to 48"W shelf capacity; 800 lbs; over 48"W shelf capacity: 600 lbs.; capacities based on evenly distributed loads
- Chrome finish

Shelves adjust at 1" increments. Optional clamps join shelving together to form rows. NSF certified. *IN STOCK.*



Two shelving units connected with clamps shown: one 36"Wx24"Dx72"H shelving unit with optional shelf dividers and back and side ledges and one 48"Wx24"Dx72"H shelving unit.



ADDITIONAL COMPONENTS AVAILABLE, CALL FOR INFORMATION.

Overall WxDxH	Shelf Cap. Lbs.	Shelf Qty.	COMPLETE UNITS	
			Stock No.	\$
24x18x72"	800	4	6042900-S	126.00
36x18x72"	800	4	5679900-V	131.00
48x18x72"	800	4	5680000-U	163.00
60x18x72"	600	4	6043000-S	212.00
72x18x72"	600	4	6043100-S	244.00
24x24x72"	800	4	6043200-S	212.00
36x24x72"	800	4	6043300-S	166.00
48x24x72"	800	4	5680100-U	200.00
60x24x72"	600	4	5680200-U	235.00
72x24x72"	600	4	5680300-U	268.00

Overall WxDxH	Shelf Cap. Lbs.	Shelf Qty.	COMPLETE UNITS	
			Stock No.	\$
24x18x86"	800	4	6043400-S	132.00
36x18x86"	800	4	6043500-S	128.00
48x18x86"	800	4	6043600-S	151.00
60x18x86"	600	4	6043700-S	217.00
72x18x86"	600	4	6043800-S	250.00
24x24x86"	800	4	6043900-S	218.00
36x24x86"	800	4	6044000-S	172.00
48x24x86"	800	4	6044100-S	186.00
60x24x86"	600	4	6044200-S	371.00
72x24x86"	600	4	5680400-U	289.00

Call for Wire Shelving options!



RELIUS SOLUTIONS
Shelves for Wire Shelving



RELIUS SOLUTIONS
Shelf Dividers for Wire Shelving



RELIUS SOLUTIONS
PVC Shelf Liners

Ships same day for 1-3 day delivery

Ships 1-5 days

SECURE STORAGE AREA



SECTIONAL INDEX

Wire Enclosures.....26-27
 Safety Cabinets & Lockers.....28-29
 Security Trucks.....30-31

Control access to equipment and resources with wire enclosures, security trucks, modular storage lockers, and safety/vault cabinets. Open mesh enclosures and lockers allow for airflow and visibility, while OSHA compliant safety cabinets keep your warehouse safe from hazardous materials. If you are in need of secure mobile storage, find the perfect security truck for your warehouse with our wide variety available in this catalog.



Order the configuration and size that best fits your needs:

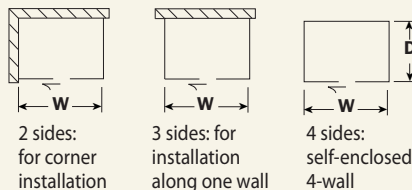

How to Order:
 (1) Sketch a rough floor plan of the area to be enclosed.
 (2) Note the overall measurements.
 (3) Contact us with your design.

CALL FOR INFORMATION ABOUT CUSTOM WIRE GUARDS



Complete Bolted Wire Enclosures

- Gray enamel finish
- 10-gauge, 1 1/2" diamond wire
- Bolted assembly

Steel channel frame. Each room has 5' sliding door with cylinder lock. 3" sweep space under all panels and doors. Each order includes: basic bolt-together hardware, floor shoes, and top capping channel. Security rooms with ceilings come with ceiling angle in place of top capping channel. **FACTORY QUICK SHIP.**

Overall WxDxH	ROOM WITHOUT CEILING						SECURITY ROOM WITH CEILING					
	2 SIDES		3 SIDES		4 SIDES		2 SIDES		3 SIDES		4 SIDES	
	Stock No.	\$	Stock No.	\$	Stock No.	\$	Stock No.	\$	Stock No.	\$	Stock No.	\$
10x10x8'	4739100-V	1155.00	4740100-V	1540.00	4741100-V	1937.00	4742100-V	1700.00	4743100-V	2060.00	4744100-V	2427.00
20x10x8'	4739200-V	1573.00	4740200-V	1954.00	4741200-V	2777.00	4742200-V	2556.00	4743200-V	2900.00	4744200-V	3419.00
20x15x8'	4739300-V	1824.00	4740300-V	2440.00	4741300-V	3269.00	4766400-V	3609.00	4766600-V	4091.00	4766700-V	4749.00
20x20x8'	4754300-V	2100.00	4754400-V	2839.00	4754500-V	3689.00	4742400-V	4293.00	4743400-V	4932.00	4744400-V	5584.00
30x20x8'	4739500-V	2479.00	4740500-V	3223.00	4741500-V	4477.00	4742500-V	5773.00	4743500-V	6572.00	4744500-V	7523.00
10x10x10'	4754900-V	1364.00	4757200-V	1836.00	4758000-V	2328.00	4742600-V	1830.00	4743600-V	2322.00	4744600-V	2756.00
20x15x10'	4758300-V	2171.00	4758500-V	2982.00	4758700-V	4009.00	4742800-V	3907.00	4743800-V	4572.00	4744800-V	5372.00
20x20x10'	4739900-V	2417.00	4740900-V	3305.00	4741900-V	4361.00	4742900-V	4611.00	4743900-V	5479.00	4744900-V	6304.00

All orders are packaged in wooden crates, as shown, for easy handling and no freight damage.



HUSKY RACK & WIRE™
EZ-Matrix™
Complete Wire Enclosures

- Polyurethane finish
- 8-gauge fluted welded mesh
- EZ-clip (hook) and chalice-bolt assembly

Easy to install, modify and move. Fully modular system features 2.5" square posts and 2" square mesh fluted wire panels. Includes 4' swing door with installed keyed lock and all hardware necessary to build a 2-, 3-, or 4-sided enclosure. Ships fully crated. Call us for more options such as enclosures up to 30'H, unsupported spans up to 30'W, doors, locks, hatches, panel windows, and 3- or 4-way connections. Made in USA.



Overall WxDxH	2 SIDES		3 SIDES		4 SIDES	
	Stock No.	\$	Stock No.	\$	Stock No.	\$
8x8x8'	7687600-V	1088.00	7688400-V	1433.00	7689200-V	1878.00
12x8x8'	7687700-V	1304.00	7688500-V	1645.00	7689300-V	2321.00
10x10x8'	7687800-V	1288.00	7688600-V	1669.00	7689400-V	2021.00
12x10x8'	7687900-V	1331.00	7688700-V	1713.00	7689500-V	2382.00
12x12x8'	7688000-V	1505.00	7688800-V	2054.00	7689600-V	2733.00
16x12x8'	7688100-V	1574.00	7688900-V	2135.00	7689700-V	2880.00
16x16x8'	7688200-V	1709.00	7689000-V	2383.00	7689800-V	3129.00
20x20x8'	7688300-V	1880.00	7689100-V	2622.00	7689900-V	3496.00

Relius solutions™ **Folding Steel Security Gates**

Fold flat to the side. Can be recessed or surface mounted, brackets included. 3/4" steel channel construction. Lift and turn locking mechanism accepts a padlock with up to a 1/2" dia. shaft. Color: gray. Made in USA. *SELECTED MODELS IN STOCK.*

Pivoting Double Gates

Drop pin at center stabilizes closed doors. Rolls on 2" steel swivel casters. Made in USA.

Expanded Width	Retracted WxH	Stock Number	\$
8'	6.9"x6.5'	5472000-U	326.00
8'	6.9"x8'	5472200-U	403.00
10'	8.4"x6.5'	5472400-U	393.00
10'	8.4"x8'	5472600-U	476.00
12'	10.6"x6.5'	5472800-U	450.00
12'	10.6"x8'	5473100-U	571.00
14'	11.4"x6.5'	5473300-U	528.00
14'	11.4"x8'	5473600-U	638.00
16'	12.1"x6.5'	5473800-U	597.00
16'	12.1"x8'	5474100-U	738.00



ADDITIONAL GATE AND DOOR CONFIGURATIONS AVAILABLE, CALL FOR DETAILS.

Ships same day for 1-3 day delivery

Ships 1-5 days

SAFETY FIRST

SAFELY STORE HAZARDOUS MATERIALS & VALUABLES



4676709-S



4676409-S



4678502-S



Flammable Liquids Safety Cabinets

- Flush-mount handle with 3-point lock
- 350-lb. shelf capacity
- Trilingual "Flammable Keep Fire Away" label

Double-wall, 18-gauge welded steel construction with 1 1/2" air space. Other features include: dual 2" capped vents, ground wire connection, adjustable shelves, and leakproof 2" base sill. Units with self-closing doors close automatically at 160°F via a melting link (meets Uniform Fire Code, UFC). Made in USA. *SELECTED MODELS IN STOCK.*

- 4677800-S Extra Shelf. Fits 30-, 45-, and 90-gal. safety cabinets. For 90-gal. cabinet, order two shelves. \$55.30
- 4677900-S Extra Shelf. Fits 60-gal. safety cabinet. \$107.00

Double-Wall Safety Cabinets. Rated for type I and II containers up to 5 gallons in size. Made in USA.

Overall WxDxH	Cap. Gal.	Door Qty.	Shelf Qty.	Can Qty.	RED		YELLOW		
					Stock No.	\$	Stock No.	\$	
MANUAL-CLOSING DOORS									
43x18x44"	30	2	1	—	4676702-S	687.00	4676709-S	687.00	
43x18x65"	45	2	2	—	4676802-S	828.00	4676809-S	832.00	
31x31x65"	60	2	2	—	4676902-S	992.00	4676909-S	996.00	
43x34x65"	90	2	2	—	4681702-S	1317.00	4681709-S	1332.00	
MANUAL-CLOSING DOORS. Cabinets include Type 1, 5-gallon safety cans.									
43x18x44"	30	2	1	6	—	—	7678300-T	1055.00	
43x18x65"	45	2	2	9	—	—	7678400-T	1229.00	
31 1/2x31 1/2x65"	60	2	2	12	—	—	7678500-T	1568.00	
SELF-CLOSING DOORS									
43x18x44"	30	2	1	—	4678402-S	775.00	4678409-S	775.00	
43x18x65"	45	2	2	—	4678502-S	966.00	4678509-S	966.00	
31x31x65"	60	2	2	—	4678802-S	1114.00	4678809-S	1114.00	
43x34x65"	90	2	2	—	4682402-S	1410.00	4682409-S	1410.00	
SELF-CLOSING SLIDING DOOR									
43x18x44"	30	1	1	—	4676402-S	765.00	4676409-S	770.00	
43x18x65"	45	1	2	—	4676502-S	948.00	4676509-S	952.00	

Eagle® quality cabinets comply with OSHA standard 1910.106, are designed to meet NFPA Standards 29 and 30, and most have been tested by Factory Mutual Research and/or Underwriters Laboratories. Please note: California and portions of other localities may require self-closing safety cabinet doors. Please check your local codes before ordering.



SHIPS SAME DAY!



Doors open 180° on welded leaf hinges with brass pins.



3-point locking mechanism with malleable cast iron zinc plated handle.



UP TO 1800-LB. SHELF CAPACITY

edra Vault Cabinets

- Up to 1800-lb. capacity per shelf
- 14-gauge steel • All-welded
- Padlock handle with three-point lock

Offers superior strength and durability. Shelves adjust on 2" centers. Doors open 180° on 9-ga. welded leaf hinges with brass pins. Bolt holes in legs allow cabinet to be secured to floor. Malleable cast iron zinc plated handle accepts 7/16" dia. padlock (not included). Powder coat gray finish. Made in USA. *IN STOCK.*

Overall WxDxH	Shelf Openings	Shelf Cap. Lbs.	Stock Number	\$
36x24x78"	5	1800	4135300-T	825.00
48x24x78"	5	1600	4135700-T	974.00
60x24x78"	5	1500	4135800-T	1211.00

LITTLE GIANT Storage Lockers

- 13-gauge steel frame/sides; 12-gauge steel shelves
- All-welded
- Padlock hasp

Expanded metal has 3/4x1 1/2" diamond-shaped openings. Doors open 270° back to the sides. 3 1/2" underclearance. Choose cabinet without shelves, with welded shelves or with adjustable shelves. One-shelf cabinet with welded shelves has 34" above and below; two-shelf cabinet with welded shelves has 22 1/2" between shelves. Made in USA.

Overall WxDxH	WITHOUT SHELVES		ONE SHELF		TWO SHELVES		ONE ADJ. SHELF		TWO ADJ. SHELVES	
	Stock No.	\$	Stock No.	\$	Stock No.	\$	Stock No.	\$	Stock No.	\$
48x24x78"	5739601-V	877.00	5739602-V	915.00	5739603-V	1000.00	5739604-U	1036.00	5739605-U	1135.00
60x24x78"	5741201-V	1004.00	5741202-V	1052.00	5741203-V	1118.00	5741204-T	1183.00	5741205-V	1362.00
48x30x78"	5759401-V	956.00	5759402-V	996.00	5759403-V	1129.00	5759404-T	1130.00	5759405-U	1306.00
60x30x78"	5759701-V	1063.00	5759702-V	1135.00	5759703-V	1266.00	5759704-T	1271.00	5759705-V	1445.00
60x36x78"	5758701-V	1151.00	5758702-V	1242.00	5758703-V	1408.00	—	—	—	—
72x36x78"	5758801-V	1183.00	5758802-V	1318.00	5758803-V	1472.00	—	—	—	—



Relius solutions

Cylinder Storage Cabinets

- 13-gauge steel or 14-gauge aluminum
- Holds 4–20 cylinders

Protect cylinders behind tamperproof doors. Doors include padlock hasp (lock not included). Choose steel or heavy .081 non-sparking aluminum construction. Steel cabinets are yellow. Meet NFPA 58 and OSHA sec. 1910.110 design standards. Made in USA. *SELECTED MODELS IN STOCK.*

A



B



C

D



Cylinder Capacity	Overall WxDxH	STEEL UNASSEMBLED		STEEL SET-UP		Overall WxDxH	ALUMINUM SET-UP	
		Stock No.	\$	Stock No.	\$		Stock No.	\$
A. HORIZONTAL CABINETS. Cylinder capacity is based on max. 14" dia. cylinders.								
4	33x38x37"	7663701-U	793.00	7663702-U	804.00	30x32x33 1/2"	4609700-T	746.00
6	—	—	—	—	—	30x32x49 1/2"	4610000-T	890.00
8	33x38x70"	7663801-U	1198.00	7663802-U	1176.00	30x32x65"	4611200-T	1045.00
12	—	—	—	—	—	60x32x49 1/2"	4611500-T	1603.00
16	65x38x70"	7664001-U	2028.00	7664002-U	1957.00	60x32x65"	4611600-T	2005.00
B. UPRIGHT CABINETS								
5–10	33x37x72"	—	—	7663600-T*	1087.00	30x32x65"	4611900-T*	960.00
10–20	60x38x72"	7663400-U*	1754.00	7663500-T*	1699.00	60x32x65"	4612000-T*	1708.00
8	30x32x69"	—	—	7670900-U*	1026.00	—	—	—
12	60x32x69"	—	—	7671000-U*	1631.00	—	—	—
C. COMBINATION CABINETS								
8–10	60x31x68"	7699100-U	1994.00	—	—	60x32x65"	4614400-T	1831.00
D. LP STORAGE CABINETS								
4	30x32x36"	—	—	7670600-U*	813.00	30x32x33 1/2"	L4162-S*	738.00
8	30x32x69"	—	—	7670700-U*	1152.00	30x32x65"	L4163-S*	1099.00
16	60x32x69"	—	—	7670800-U*	1530.00	60x32x65"	L4164-S*	1886.00

NOTE: *Also meet CSA B149.2 standards.

Call for these Pallet Rack Enclosures and Safety products



FOLDING GUARD Pallet Rack Enclosures



NASHVILLE WIRE Wire Security Enclosures



NMC Lock-Out Tags



EAGLE Drum Cabinets

MOBILIZE YOUR SUPPLIES

KEEP MATERIALS SECURE & MOBILE WITH SECURITY TRUCKS

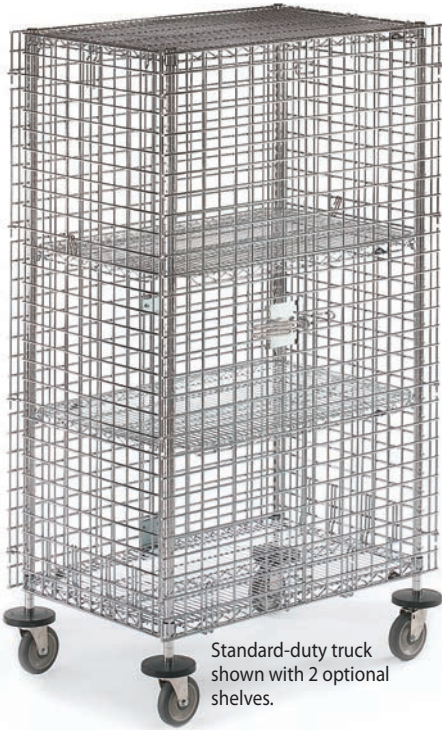

Standard-duty truck shown with 2 optional shelves.



Heavy-duty truck is mounted to an aluminum dolly for extra strength.

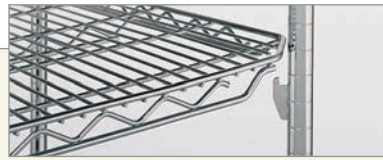

qwikSLOT™ Shelves. Easily adjustable and removable without dismantling the entire unit. Shelves are supported on clips that snap into posts at 1" intervals.

qwikSLOT™ Shelves. 300-lb. capacity per shelf.
 4785800-T 36"Wx24"D. \$75.20
 4785900-T 48"Wx24"D. \$99.90
 4788400-T 60"Wx24"D. \$110.00

METRO METRO® qwikSLOT™
Security Trucks

- Steel wire
- 800–1200-lb. capacity
- 5" polyurethane casters
- Patented 1/4-turn padlock hasp

Features easy-to-adjust qwikSLOT™ shelves. Totally enclosed design and locking doors make this truck the perfect solution for reducing theft. Open-wire construction makes it easy to monitor inventory. Order shelves separately. Ships unassembled. Made in USA.

Standard-Duty Trucks. 800-lb. capacity.

Overall WxDxH	Stock Number	\$
40 1/2"x27 1/2"x68 1/2"	4785200-T	1330.00
52 1/2"x27 1/2"x68 1/2"	4785300-T	1498.00
65x27 1/2"x68 1/2"	4785400-T	1690.00

Heavy-Duty Trucks

Wire cage is mounted on an aluminum dolly with wraparound bumper for extra strength and durability. 1200-lb. capacity.

Overall WxDxH	Stock Number	\$
38 1/2"x28 1/2"x67 1/8"	4785500-T	1581.00
50 1/2"x28 1/2"x67 1/8"	4785600-T	1852.00
63 1/2"x28 1/2"x67 1/8"	4785700-T	1956.00



ELITE Premium Security Box Trucks

- 14-gauge steel
- 3600-lb. capacity
- 6" polyurethane casters
- Welded push handle

Solid steel sides add security and increased durability. User-friendly features include side drop gate and double-hinged cover that fold down and back. Padlock hasp (lock not included). Interior height: 36". Rolls on 2 swivel, 2 rigid casters. Color: blue. German Engineered. Made in USA.



Overall WxDxH	Stock Number	\$
24x48x47"	7037300-U	766.00
30x60x47"	7037400-U	892.00

LITTLE GIANT
Visible Contents Security Trucks

- Mesh sides with 12-gauge steel frame
 - 2000-lb. capacity
 - 6" polyurethane casters
- Offers security, ventilation and visibility. Heavy-gauge reinforced deck. Double doors open 270° and include a padlock hasp. 46 1/2" interior height. Rolls on non-marking wheels—2 swivel, 2 rigid. Made in USA. Specify: (01) without shelf, (02) with one fixed shelf, (03) with two fixed shelves, (04) with one adjustable shelf on 3 1/2" centers. **SELECTED MODELS WITH (02) ONE FIXED SHELF ARE IN STOCK.**



49168-S shown with (02) one fixed shelf.

Overall WxDxH	Stock Number	(01) WITHOUT SHELF	(02) ONE FIXED		(03) TWO FIXED		(04) ONE ADJUSTABLE
		\$	Shelf Clearance	\$	Shelf Clearance	\$	\$
48x24x56"	49167-S	750.00	21 1/2"	735.00	14"	835.00	852.00
48x32x56"	49168-S	780.00	21 1/2"	803.00	14"	890.00	907.00
60x32x56"	49169-S	863.00	21 1/2"	890.00	14"	977.00	994.00
60x36x56"	49170-S	898.00	21 1/2"	986.00	14"	1119.00	—
72x36x56"	49171-S	936.00	21 1/2"	1034.00	14"	1197.00	—

ELITE Wire Security Trucks

- Steel wire • 2000-lb. capacity
- Multiple caster choices available
- Hardened steel padlock hasp

All-welded 2x2" steel grid panels make this one of the strongest trucks on the market. Provides total security and see-through visibility. Use the plastic shelf clips to attach shelves anywhere on the grid panels (4 shelf clips included with each shelf). Doors include four heavy-duty greasable hinges. 250-lb. capacity shelves are available in 14-gauge steel or 3/4" layered wood. Two swivel with Total Lock brakes, two rigid casters. Painted finish. Padlock not included. Made in USA. **SELECTED MODELS IN STOCK.**

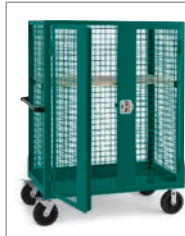

7705812 shown with optional wood shelf and 8" black mold-on rubber casters.



7706118 shown with 8" black mold-on rubber casters.



Shown with optional accessories: steel shelf 59634(18), hitch system 59742(18), fork pockets 59890(18), rubber mat 2837200, and louvered panel insert 59738(18).

NEW
STYLES

Optional Shelves

Made in USA. For steel shelves, specify color: (02) red, (12) green, (18) blue, (28) dk. gray.



Overall WxD	WOOD		STEEL	
	Stock No.	\$	Stock No.	\$
60x30"	5996600-T	98.10	59635-T	88.80
48x24"	5969600-T	90.30	59634-T	73.50

Optional Panel Inserts

Made in USA. Specify color: (02) red, (12) green, (18) blue, (28) dk. gray.

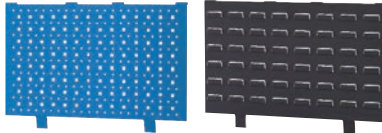

Size	PEGBOARD		LOUVERED	
	Stock No.	\$	Stock No.	\$
23 1/2"x19"	59737-T	44.70	59738-T	35.70

Choose from 3 caster types

- A. 5" polyurethane
- B. 8" black mold-on rubber
- C. 8" gray non-marking rubber



Overall WxDxH	Cap. Lbs.	RED	GREEN	BLUE	DARK GRAY	\$
		Stock No.	Stock No.	Stock No.	Stock No.	
A. 5" POLYURETHANE						
60x30x60"	2000	7705602-U	7705612-U	7705618-U	7705628-U	1406.00
48x30x60"	2000	7705902-U	7705912-U	7705918-U	7705928-U	1266.00
48x24x60"	2000	7706202-U	7706212-U	7706218-U	7706228-U	1078.00
B. 8" BLACK MOLD-ON RUBBER						
60x30x60"	2000	7705802-U	7705812-U	7705818-U	7705828-U	1406.00
48x30x60"	2000	7706102-U	7706112-U	7706118-U	7706128-U	1335.00
48x24x60"	2000	7706402-U	7706412-U	7706418-U	7706428-U	1076.00
C. 8" GRAY NON-MARKING RUBBER						
60x30x60"	2000	7705702-U	7705712-U	7705718-U	7705728-U	1419.00
48x30x60"	2000	7706002-U	7706012-U	7706018-U	7706028-U	1278.00
48x24x60"	2000	7706302-U	7706312-U	7706318-U	7706328-U	1089.00

Accessories. Specify color: (02) red, (12) green, (18) blue, (28) dk. gray.

- 59742-T Hitch System. Includes tow bar and hitch. \$.....142.00
- 59890-T Fork Pockets. Sold in packages of 4. \$ Pkg.102.00
- 5973900-T Sixth-Wheel Swivel Caster Package. Sold in packages of 2. \$ Pkg.60.70
- 2837200-U Optional rubber mat. 48x24". \$.....29.00
- 2836800-U Optional rubber mat. 48x30". \$.....39.00
- 2837300-U Optional rubber mat. 60x30". \$.....81.00

Vestil Collapsible Security Truck

- Wire mesh walls with steel frame
- 2000-lb. capacity
- 6" mold-on rubber casters

When folded, truck is only 6" deep letting you store it practically anywhere. Center shelf folds down to create two 32 1/2" areas or remains in the up position to give you a full 66 1/2" of storage. Door locking latch and padlock hasp (padlock not included). All swivel casters, 2 with brakes. Stores folded. Color: gray enamel. **IN STOCK.**

5234601-S 44"Wx27"Dx76 1/2"H. \$.....1045.00

SHIPS SAME DAY!



Folds down to 6" deep for convenient storage.



Doors closed.



Doors open.

Call for these products and MORE!



EDSAL Mobile Security Computer Workstations



Wire Truck Covers



SANDUSKY LEE Mobile Visibility Cabinets



DURHAM Clear-View Cabinets



FIREKING Fire-Resisting File Cabinets

Ships same day for 1-3 day delivery

Ships 1-5 days

EQUIPMENT STORAGE AREA



SECTIONAL INDEX

Storage Lockers	32
Perimeter Guards	33
Railing Systems	34
Storage Sheds	34
Skid Containers	35

Choose from a wide variety of options to store and protect your warehouse equipment, including lockers, perimeter guards and sheds. Protect people, machinery and inventory from impacts with guardrail systems. Store products in the same container you'll ship them in with skid containers. Call us for even more options!



Single-tier starter and double-tier add-on shown.

Hallowell



Modular Storage Lockers

- 13- to 14-gauge steel frame/sides; 16-gauge steel shelves
- Unassembled • Padlock hasp

16-gauge, 1/2" expanded metal. Doors open 180° and have welded padlock hasps. Double-tier design includes non-removable reinforced center shelf. Pre-punched holes on panels allow easy installation. Basic hardware included. Platinum zinc powder coat finish. Made in USA. **FACTORY QUICK SHIP.**

Overall WxDxH	STARTER		ADD-ON	
	Stock No.	\$	Stock No.	\$
SINGLE-TIER LOCKERS				
36x36x90"	5823800-S	354.00	5824400-S	267.00
36x48x90"	5823900-S	416.00	5824500-S	306.00
36x60x90"	5824000-S	476.00	5824600-S	344.00
48x36x90"	5824100-S	416.00	5824700-S	306.00
48x48x90"	5824200-S	488.00	5824800-S	360.00
48x60x90"	5824300-S	563.00	5824900-S	411.00
DOUBLE-TIER LOCKERS				
36x36x90"	5825000-S	428.00	5825600-S	354.00
36x48x90"	5825100-S	497.00	5825700-S	402.00
36x60x90"	5825200-S	570.00	5825800-S	451.00
48x36x90"	5825300-S	497.00	5825900-S	396.00
48x48x90"	5825400-S	585.00	5826000-S	467.00
48x60x90"	5825500-S	673.00	5826100-S	538.00

Optional Tops

Overall WxD	Stock Number	\$
36x36"	5826200-S	43.80
36x48"	5826300-S	46.40
36x60"	5826400-S	48.70
48x36"	5826500-S	55.20
48x48"	5826600-S	60.30
48x60"	5826700-S	65.50

Optional Backs

Overall WxH	Stock Number	\$
36x90"	5826800-S	97.00
48x90"	5826900-S	118.00



All panels and doors are crated to prevent damage during shipping.



Shown: (5) panels, (6) posts, swing door, and interlock switch/actuator.

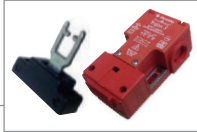

Visible in photo:
 (3) 7922500-V panels,
 (1) 7222900-V panel,
 (2) 7923200-V corner posts,
 (2) 7923000-V line posts.



Perimeter Guards

EZ Wire® Perimeter Guards

- 10-ga., 2" woven wire mesh panels
 - EZ-clip (hook) and pin assembly
- Patented hook fastener slips into 2 1/2" sq., 14-ga. tube post. Universal posts include lags and plastic end caps. Swing door with padlock hasp in handle, padlock not included. 12" sweep space. Meets ANSI requirements. Made in USA.

Posts

Size	Stock No.	\$
2 1/2" sq. x 6'H	4826100-S	86.30

Panels

Overall Ht.	Width	Stock No.	\$	\$ (6+)
60"	12"	4825000-S	61.50	58.50
60"	24"	4825100-S	67.30	64.00
60"	36"	4825200-S	95.90	91.20
60"	48"	4825300-S	128.00	122.00
60"	60"	4825400-S	151.00	144.00
60"	72"	4825500-S	174.00	166.00
60"	84"	4825600-S	194.00	185.00
60"	96"	4825700-S	212.00	202.00
60"	108"	4825800-S	227.00	216.00
60"	120"	4825900-S	237.00	226.00

4826000-S	Swing door.	\$	246.00
7844200-T	Interlock switch.	\$	333.00
7844100-T	Actuator.	\$	85.90

Matrix Guard® Machinery and Robotic Guards

- 8-ga., 2" square fluted welded mesh
 - EZ-clip (hook) and chalice bolt assembly
- Chalice bolt panel fastener attaches to 2 1/2" sq., 14-ga. tube post. Posts include lags and plastic end caps. 6" sweep space meets robotic equipment requirements. Swing door with padlock hasp in handle, padlock not included. Made in USA. **FACTORY QUICK SHIP.**

Posts

Description	Size	Stock No.	\$
Line Post. 2 1/2" sq. x 72"H.	2 1/2" sq. x 72"H	7923000-V	79.40
Door Post. 2 1/2" sq. x 72"H.	2 1/2" sq. x 72"H	7923100-V	96.30
Adjustable Corner Post. 2 1/2" sq. x 72"H.	2 1/2" sq. x 72"H	7923200-V	117.00

Panels

Overall Ht.	Width	Stock No.	\$
66"	10"	7922200-V	55.50
66"	22"	7922300-V	70.50
66"	34"	7922400-V	84.60
66"	46"	7922500-V	95.30
66"	58"	7922600-V	118.00
66"	70"	7922700-V	131.00
66"	82"	7922800-V	142.00
66"	94"	7922900-V	155.00

7923300-V Swing Door. 48"Wx66"H.. \$.....301.20



Infinitely Adjustable Perimeter Guard System

- 8-ga. 1 1/2" x 1 1/2" wire mesh panels
- Unique pin and bracket panel system lets you configure guards in any design, including circles and octagons. Panels may be installed at any angle from 0-180°. 2" sq., 14-ga. tube post with 1/4" thick base. Hinged door is furnished with a keyed cylinder lock for security. Powder coated steel. Ships unassembled. Meets OSHA, EPA, and ANSI requirements.

8'H panel

5' hinged door

3'H panel

5'H panel

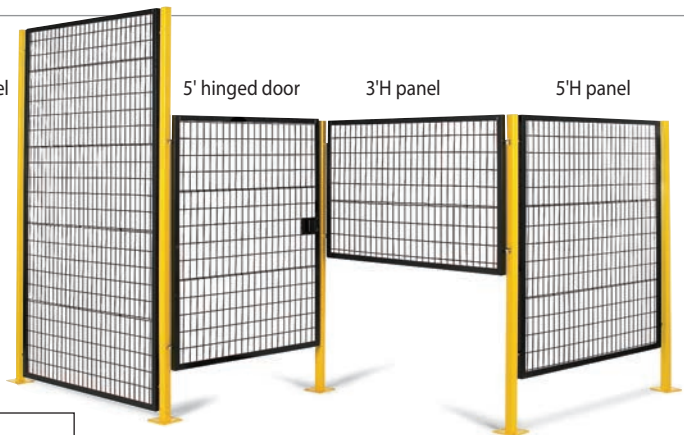

Panels

Overall Height	Overall Width	Stock Number	\$
36"	60"	7808600-S	105.00
36"	96"	7808700-S	144.00
48"	60"	7808800-S	123.00
48"	96"	7809200-S	166.00
60"	60"	7809300-S	141.00
60"	96"	7809400-S	191.00
72"	60"	7809500-S	153.00
96"	60"	7809600-S	191.00

Posts

Description	Overall Height	Stock Number	\$
In-Line Post	72"	7810000-S	102.00
Corner Post	72"	7810100-S	101.00
In-Line Post	96"	7810200-S	114.00
Corner Post	96"	7810300-S	111.00

7810400-S 60"Hx48"W Hinged Door. \$.....487.00

Ships same day for 1-3 day delivery

Ships 1-5 days

PROTECT & PREVENT

SAFEGUARD AGAINST DAMAGE & PREVENT THEFT



Shown: (2) double posts with (2) 4' rails combined with a single post and 8' rail.



Two-Rib Steel Protective Railing Systems

- 11-ga. steel
- Unassembled components
- Mounting hardware included

Absorbs the impact of a 13,000-lb. load at 4 mph. Rolled top edge. Columns: 5" sq, 3/16" thick. Baseplate: 12" sq., 3/4" thick. Lift-out rails slip into specially designed "saddle", which is bolted to post to retain structural integrity. Install with concrete anchors. High-visibility yellow enamel finish. Made in USA. *IN STOCK.*



Overall Length	STANDARD RAILS		LIFT-OUT RAILS	
	Stock No.	\$	Stock No.	\$
10'	4228000-T	283.00	4231100-T	427.00
9'	7291400-T	276.00	—	—
8'	4228100-T	235.00	4231500-T	414.00
7'	7291500-T	228.00	—	—
6'	4228200-T	204.00	4232000-T	374.00
5'	7291600-T	201.00	—	—
4'	4228300-T	172.00	4232100-T	356.00
3'	7291700-T	158.00	—	—
2'	7291800-T	145.00	—	—

Overall Height	Description	STANDARD POSTS			LIFT-OUT POSTS		
		Stock No.	\$	\$(3+)	Stock No.	\$	\$(3+)
18"	Single Post	4226000-S	233.00	222.00	4249600-S	249.00	237.00
44"	Double Post	4226100-S	345.00	328.00	4249700-S	371.00	353.00
44"	Triple Post	4268100-S	442.00	420.00	—	—	—

Self-Closing Gate. Designed to replace a 4' double rail section. Spring-loaded gate closes via a latching mechanism. May be attached on either the left or right hand side.

4214100-S \$694.00



Vestil Quick-Assembly High-Security Storage Sheds

• 330 or 699 cubic feet of storage • Unassembled
Assembles in 30 minutes or less in 12 simple steps. Galvanized steel construction. 45"Wx74"H doorway features hinged solid door with padlock hasp (lock not included). Includes wooden floor and rain gutters. Requires only a firm, level surface—no additional foundation needed. Made in USA.

Overall WxDxH	Door Opening WxH	Cap. Cu. Ft.	Stock Number	\$
110x73x85"	45x74"	330	2902100-S	2802.00
110x150x85"	45x74"	699	2902200-S	5199.00

MORE SHEDS ARE AVAILABLE, CALL FOR DETAILS



Poly Column Protectors

Stress- and crack-resistant guards wrap around uprights creating a lightweight barrier. Bumper should fit snugly around upright. Stackable. Fasteners included. Made in USA. *SELECTED MODELS IN STOCK.*

Low-Profile Column Protectors

Low-profile unit offers the same impact resistance as taller column protectors at a lower cost. Stress- and crack-resistant polyethylene material. Bumper should fit snugly around upright. Fasteners included. Made in USA. *SELECTED MODELS IN STOCK.*

Key	Fits Column Size	Overall WxH	Stock Number	\$
UV-PROTECTED POLYETHYLENE. Color: yellow.				
A	12x12"	24x42"	4200901-V	268.00
A	10x10"	24x42"	4200902-V	268.00
A	8x8"	24x42"	4200903-V	268.00
A	6x6"	24x42"	4200904-V	268.00
A	8x10"	24x42"	4200905-V	268.00
A	9" dia.	24x42"	4200906-V	268.00
A	14x14"	30x42 ³ / ₄ "	4217707-V	549.00
A	16x16"	30x42 ³ / ₄ "	4217708-V	549.00
A	18x18"	30x42 ³ / ₄ "	4217709-V	549.00
B	3x3"	12x42"	4222201-S	173.00
B	4x4"	12x42"	4222202-S	173.00
B	5x5"	12x42"	4222203-S	173.00
B	6x6"	12x42"	4222204-S	173.00
UV-PROTECTED POLYETHYLENE. Color: orange. Includes two glow-in-the-dark strips.				
C	12x12"	26x42"	4225101-S	542.00
C	10x10"	26x42"	4225102-S	542.00
C	8x8"	26x42"	4225103-S	542.00
C	6x6"	26x42"	4225104-S	542.00
C	8x10"	26x42"	4225105-S	542.00
C	9" dia.	26x42"	4225106-S	542.00
C	14x14"	30x42 ³ / ₄ "	4236007-S	769.00
C	16x16"	30x42 ³ / ₄ "	4236008-S	769.00
C	18x18"	30x42 ³ / ₄ "	4236009-S	769.00

Key	Fits Column Size	Overall WxH	Stock Number	\$
UV-PROTECTED POLYETHYLENE. Color: yellow.				
D	12x12"	24x24"	4252201-T	176.00
D	10x10"	24x24"	4252202-T	176.00
D	8x8"	24x24"	4252203-T	176.00
D	6x6"	24x24"	4252204-T	176.00

Ships same day for 1-3 day delivery

Ships 1-5 days

CONTACT US!

ALL PRICES WILL BE DISCOUNTED EVEN MORE!

Call DICK JONES SALES 800-441-9955 or

E-mail DickJones@DickJonesSales.com

ORBIS®



Translucent *FliPak*® Totes

- Injection-molded polyolefin
- Stack and nest
- Includes flip lid

See-through polypropylene construction permits easy visual identification of contents. Partially filled containers will not collapse while stacked. Designed to optimize space on pallets and in trucks, trailers, and warehouses. Attached lid, with solid metal hinge pin, closes tightly. High-strength injection-molded polyolefin construction offers maximum product protection from impact, moisture, chemicals, vermin, etc. Appropriate for lean manufacturing. Made in USA. *IN STOCK.*

Overall LxWxH	Cap. Cu. Ft.	Stock Number	Reg. \$	SALE \$
21 ¹ / ₂ 'x15 ¹ / ₂ 'x9 ¹ / ₂ '"	1.4	6100500-T	34.00	22.00
21 ¹ / ₂ 'x15 ¹ / ₂ 'x12 ² / ₁₀ '"	1.8	6100600-T	36.10	23.90
26 ² / ₁₆ 'x16 ¹⁵ / ₁₆ 'x12 ¹ / ₈ '"	3.2	6100700-T	47.90	32.00